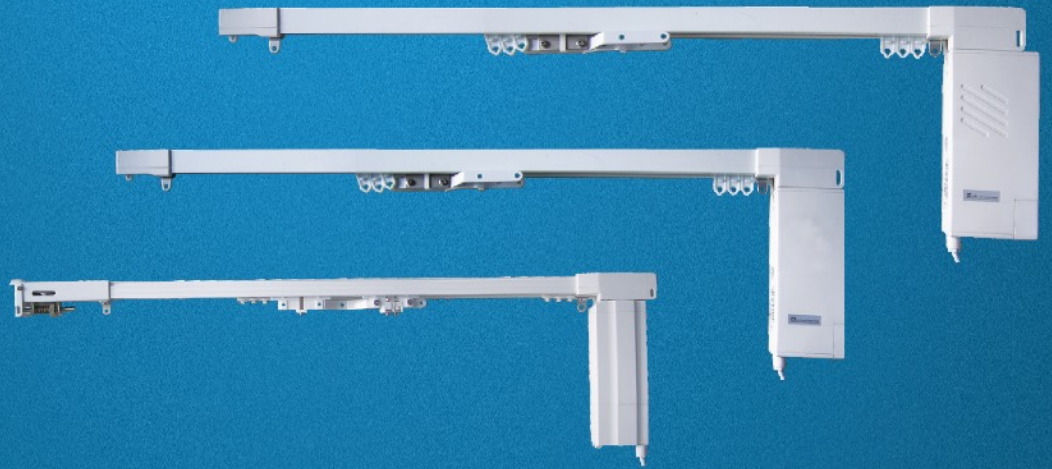


07-15-2019



DRAPERY HARDWARE

Motorized Drapery Rod - Roller Shade - Zebra Shade
30+ Years in the market of window covering

Table Of Contents

<u>Guide on How to Order</u>	<u>Heavy Duty and Regular Duty Cut to Measure Rodding and Components</u>
Guide on how to order.....2	Track, Master Carrier and Pulley.....61
C.T.M. H.D. Traverse Rod.....4	Glides, Pendant and Bracket.....63
C.T.M. Roller, Austrian and Roman Shade.....5	Regular Duty C.T.M. Parts.....65
C.T.M. Drapery Motorizing Assembling Set.....8	Oval Rod Components.....66
C.T.M. Tubular Motorizing Assembling Set.....9	<u>Workroom Supply</u>
Wood Traverse Rod.....12	Cord.....67
<u>DK Product Collection</u>	Buckram, Lead Weight and Pins.....68
Decorative Wood Hand Carving.....19	Drapery Pin Hooks and Pin Gun.....69
DK Wood Pole and Components.....31	Shears, Canvas, Lamp and Tassel.....70
Tieback Holders.....40	Shade Pulley, Cord lock and Roman Shade Rib.....71
Iron Rod Set, Iron Rod and Components.....41	Grommets.....72
3/8" Solid Rodding and Components.....49	Tapes.....74
Aluminum Brass Anodized Tube and Components	Fluids.....79
Brass Rod and Components.....50	Staples and Guns.....80
Tie Back Holder.....53	Installer Tools.....81
Chrome Finishing Rod and components.....54	Screws.....83
Brush Chrome Finishing Rod and components.....55	Molly Anchors/Bolt.....85
<u>Heave Duty Traverse Rod</u>	Corner Irons.....86
Meteor Traverse Rod "Drop-in" Type.....56	Batons.....87
<u>Curtain Rod</u>	<u>Architectural Aluminum Track and Components</u>
Cafe Rod.....57	Series 80-9046.....89
Sash Rod and Spring Tension Rod.....58	Series 80-9600.....90
Curtain Rod.....59	Series 80-9001.....92
2-1/2" and 4" Contempo Curtain Rod.....60	Series 80-9003.....93
	Series 80-9004.....94
	Series 80-7900.....96
	Ripple fold Snap Tape and Batons.....97
	H.D. I Bean and Standard I Bean Track.....98

To Order Custom Color on Wood Pole Parts

Custom color finished charge is based on the unfinished price plus a \$35.00 set-up charge and others as mention below

	For 1" & 1-3/8"		For 2" & 2-1/4"		For 3"	
	Custom Color	Gold Leaf	Custom Color	Gold Leaf	Custom Color	Gold Leaf
Wood Pole	\$4.00 ft	\$14.30 ft	\$5.00 ft	\$16.25 ft	\$6.00 ft	\$19.50 ft
Pole End	\$5.00 ea	\$8.45 ea	\$6.00 ea	\$11.70 ea	\$7.00 ea	\$13.00 ea
Wood Bracket	\$5.00 ea	\$8.45 ea	\$6.00 ea	\$11.70 ea	\$7.00 ea	\$13.00 ea
Wood Ring	\$1.00 ea	\$2.60 ea	\$1.50 ea	\$3.25 ea	\$1.80 ea	\$3.90 ea
Other Parts - Same as Pole Ends						

Please Note

*Provide Sample for Matching of Color.

Our color are hand painted and exclusively done at our premises.

For best match on your color we advise you to provide us with your color sample.

*Due to the Difference in wood grains and hand finishes of our products. We can not Guarantee an absolute color.

*Please allow 10 to 12 working days for delivery on all colors.

How to Order

For Express Service, have the item No., Quantity, Color Number (finish) and Size terms - Net 30 Days

Shipment

Orders totaling \$500.00 or more at book price are prepaid via te most economical way. If other than the most economical way is specified, difference will be charge to the dealer. Drop shipments will be prepaid with charges added to invoice. Any claims for shortage or discrepancies must be reported promptly upon receipt of shipment no later than 30 days. Applies to continental US only.

UPS Limits

130 Inches length and girth combined, 108 inches maximum length. Some items, when shipped in full pack or multicultural quantities, may exceed UPS limits. Every attempt will be made to ship by the least costly means possible.

Payment of Invoices

Remit to the address on the invoice. Please pay no accounts to salesman or other places except on out written order.

Credit

Open accounts are solicited with dealers who have established credit. If you are not sure that your financial responsibility is given in the standard rating books, please include banking and business references with your order and as much additional information as you care to give.

Loss and Damage

Available upon request, is a copy of the original bill of landing signed by the transportation company, which is accepted as conclusive proof that the goods were delivered to the carrier in perfect condition. Loss or damage in transit should be taken up by you or the transportation company. When filing claims, present itemized statement, original bill of landing and copy of invoice.

Delays

All orders will receive careful and prompt attentions. This company will no be responsible for unavoidable delays in making shipment, or delays over which it has no control.

State and/or local sales taxes will be applied where applicable.

Return Goods

No return after 30 days of invoice date and additional 20% Re-stocking charge

When desiring to return any merchandise, first, write for permission to same place where shipment was made, giving reason for returning, description, quantity, invoice date and number covering shipment. Returned good will not be accepted unless permission in obtained. Any return merchandises us be in original cartons and listed in out current price list. Returned goods are to be sent prepaid to the original shipping place from which your shipment was made. If we are not at fault, a handling and re-stocking chase of 20%, will be made.

All prices subject to change without notice. Price do not include any Federal, State or Local Taxes

Made to Measure Traverse Rods

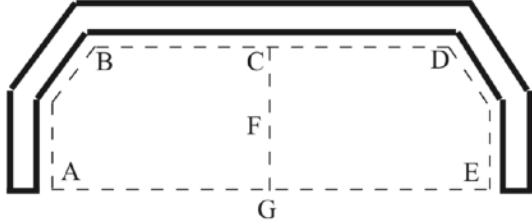
Curved or Bent Track

When ordering track sets please note the following instructions

1. Designate Style of Track: Heavy Duty or Standard
2. Clearly state ser number as indicated
3. Specify whether it is "type" I-II-III-IV-V, give dimensions as indicated, A-B-C, etc

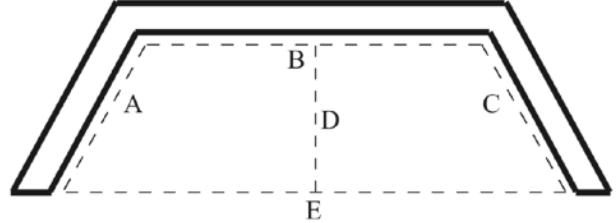
Made to Measure Traverse Rods for Corner, Bays and Windows

I



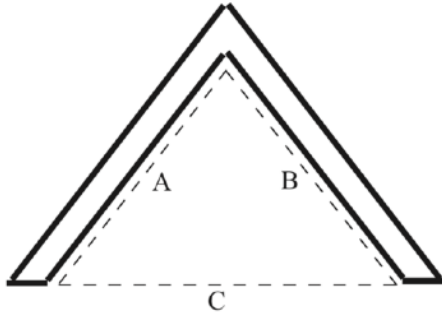
Use this diagram when ordering **Bay Window Rods** with four bends using actual window measurements

II



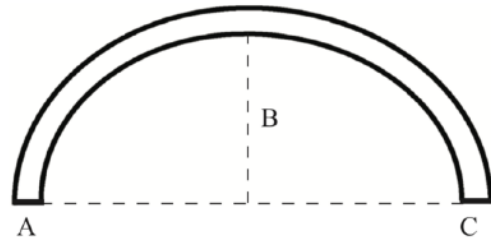
Use this diagram when ordering **Bay Window Rods** with two bends using actual window measurements shown on this diagram is used angle is more than 90.

III



Please include the above diagram when ordering **Corner Window Traverse Rods.** Give accurate and actual window measurements.

IV



Please include the above diagram when ordering **Curved Traverse Rods.** Give accurate and actual window measurements.

Be sure to specify whether mounting to ceiling (with stirrup) or brackets and supports.

Add this cost for bending

First bend per rod \$15.00, succeeding bend \$10.00

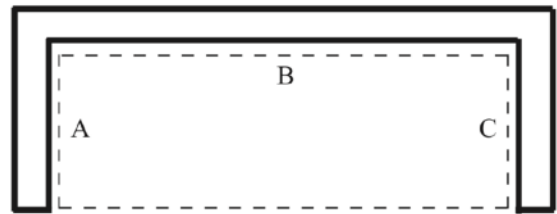
Curved Rod

\$1.50 ea per ft. Minimum charge is \$15.00

Crating Charge

Curved track minimum charges \$20.00 or 20% of curser track order

V



Please include the above diagram when ordering **Bay Window Traverse Rods.** Which have bends and angles of 90.

Ordering Information

Made to measure curved and corner windows rods are shipped completely assembled, ready for easy installation.

When ordering be sure to specify

1. Stock number
2. Heavy duty or Standard track
3. Rod description
Hand or cord traversed, if installation is to be made on ceiling, casing or recessed
4. Measurements
Give all measurements, angles and projections.
Be sure to indicate a simple diagram of the window as indicated above. Angle in degrees can be determined by protractors



Made to Measure Traverse Rod

Item Code	Size	Single	Double
1	Up to 36"	\$12.14	\$24.28
2	37" - 48"	\$14.98	\$29.96
3	49" - 60"	\$17.26	\$34.52
4	61" - 72"	\$19.53	\$39.06
5	73" - 84"	\$21.82	\$43.64
6	85" - 96"	\$24.12	\$48.24
7	97" - 108"	\$26.40	\$52.80
8	109" - 120"	\$28.60	\$57.20
9	121" - 132"	\$30.70	\$61.40
10	133" - 144"	\$33.26	\$66.52
11	145" - 156"	\$35.55	\$71.10
12	157" - 168"	\$37.83	\$75.66
13	169" - 180"	\$40.05	\$80.10
14	181" - 192"	\$42.38	\$84.76
15	193" - 204"	\$44.66	\$89.32
16	205" - 216"	\$46.95	\$93.90
17	217" - 228"	\$49.25	\$98.50
18	229" - 240"	\$51.53	\$103.06
19	241" - 252"	\$53.82	\$107.64
20	253" - 264"	\$56.10	\$112.20
21	265" - 276"	\$58.38	\$116.76
22	277" - 288"	\$60.65	\$121.30
23	289" - 300"	\$62.94	\$125.88

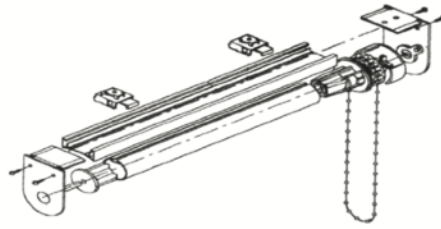
40-8664 Stationary Rod No Cord (4ft-under) \$7.95, Extra ft. Add \$1.50

Note: To identify price, add item code after the item number.

Ex: Item No. 40-50XX : Center Open / Single 40-60XX : Center Open / Double
 40-51XX : One way right / Single 40-61XX : One way right / Double
 40-52XX : One way left / Single 40-62XX : One way left / Double



Roller, Austrian & Roman Shade



Made to Measure Roller, Austrian & Roman Shade

A. 1-1/4" Tube - Assembled Roller, Austrian & Roman Shade without Aluminum head Rail & Bottom Rail - Ceiling Mount

Item Number	Size	Price
80-3603B	Up to 36"	\$38.16
80-3604B	37" - 48"	\$41.56
80-3605B	49" - 60"	\$44.98
90-3606B	61" - 72"	\$48.37
80-3607B	73" - 84"	\$51.78

B. 1-1/2" Tube - Assembled Roller, Austrian & Roman Shade without Aluminum head Rail & Bottom Rail - Ceiling Mount

Item Number	Size	Price
80-3803	Up to 36"	\$44.21
80-3804	37" - 48"	\$47.96
80-3805	49" - 60"	\$51.73
80-3806	61" - 72"	\$55.43
80-3807	73" - 84"	\$70.88

C. 2" Tube - Assembled Roller, Austrian & Roman Shade without Aluminum head Rail & Bottom Rail - Ceiling Mount











Item Number	Size	Price
80-3906	61" - 72"	\$70.38
80-3907	73" - 84"	\$77.86
80-3908	85" - 96"	\$85.23
80-3909	97" - 108"	\$100.28

More than 9ft long, recommend motorizing



Roller, Austrian & Roman Shade Components







For 1-1/4" Tube

Illustration	Item No	Description	Full Pack		Broken Pack
			Q'ty	Price	
1-1/4" Aluminum Tube  80-3665	80-3665	1-1/4" Aluminum Tube	160 ft	\$2.16	\$2.76
1-1/4" Control System Set  80-6328	80-6328	1-1/4" Control System Set	10 ea	\$8.24	\$10.42
Roller  80-3388	80-3388	Roller	20 ea	\$2.17	\$2.73
Chain Type - Spring Set  80-6321 80-6322	80-6321	10"	10 ea	\$14.38	\$15.59
	80-6322	14"	10 ea	\$15.66	\$16.87
Aluminum Bottom Rail (Silver)  80-3352	80-3352	Aluminum Botton Rail Silver	160 ft	\$1.55	\$1.91
End Cap for Bottom Rail  80-2011	80-2011	End Cap for Botton Rail	20 ea	\$0.18	\$0.25
Aluminum Head Rail (white)  80-3497	80-3497	Aluminum Head Rail For Roller Shade - White	160 ft	\$1.08	\$1.51
Bracket for Head Rail  80-0025	80-0025	Bracket for Head Rial	20 ea	\$1.27	\$1.78
	80-9688-1	No. 10 Metal Bead Chain	100 ft	\$1.31	\$1.61
	80-9688-2	No. 10 Metal Bead Chain	333 ft (100m)	\$1.09	
PVC Insert  80-0290	80-0290	PVC Insert	160 ft	\$0.14	\$0.18
Double Side Adhesive Tape 80-1024	80-1024	3/4" Double Side Adhesive Tape 60 yard/roll	5 rl	\$18.76	\$19.97
Operation Chain Connector 80-5410	80-4410	Operation Chain Connector (4.5mm)	100 ea	\$0.42	\$0.61



Roller, Austrian & Roman Shade Components

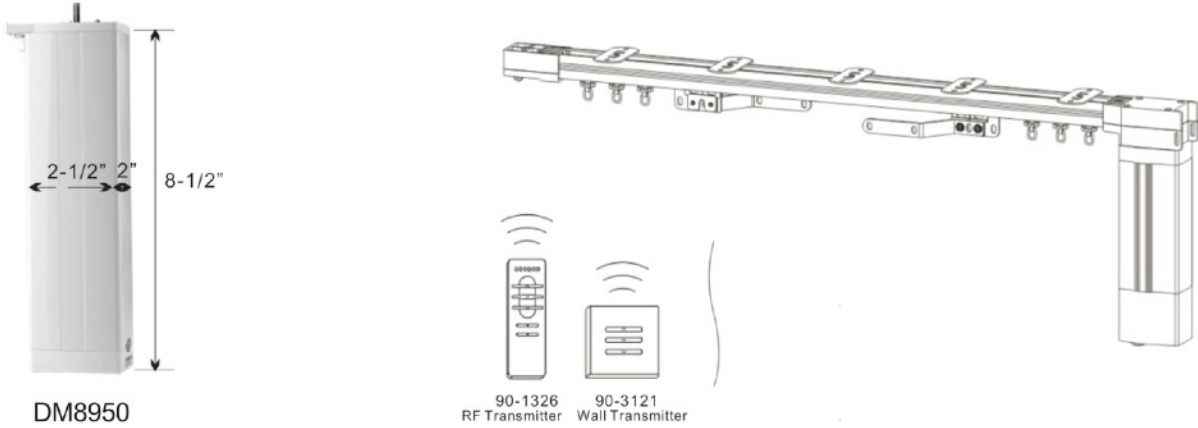
For 1-1/2" Tube

Illustration	Item No	Description	Full Pack		Broken Pack
			Q'ty	Price	
1-1/2" Aluminum Tube  80-3765	80-3765	1-1/2" Aluminum Tube	160 ft	\$2.40	\$3.14
1-1/2" Control System Set  80-6428	80-6428	1-1/2" Control System Set	10 ea	\$10.37	\$12.06
Roller  80-3390	80-3390	Roller For 1-1/2"	20 ea	\$2.35	\$2.96
Aluminum Bottom Rail (Silver)  80-3768	80-3352	Aluminum Botton Rail Silver	160 ft	\$1.55	\$1.91
End Cap for BottomRail  80-2022	80-2011	End Cap for Botton Rail	20 ea	\$0.18	\$0.25
	80-9688-1	No. 10 Metal Bead Chain	100 ft	\$1.31	\$1.61
	80-9688-2	No. 10 Metal Bead Chain	333 ft (100m)	\$1.09	
Double Side Adhesive Tape 80-1024	80-1024	3/4" Double Side Adhesive Tape 60 yard/roll	5 rl	\$18.76	\$19.97
Operation Chain Connector 80-5410	80-4410	Operation Chain Connector (4.5mm)	100 ea	\$0.42	\$0.61



Motorizing Drapery Rod Assembling Set

Model: Galaxy - DC Motor DM8950
 Max. Load Capacity: Up to 150 lbs
 Textile Operating System



Specifications

Rated Voltage	Rated Torque	Max Load Capacity	Rated Frequency	Rated Power Input	Rated Speed	Self-Protection Time
110 V	0.4 Nm	150 lbs	60 Hz	90 w	133 rpm	6 min

Item # 90-4950-XX (Item Code)

Size (Code)	Up to 72" (06)	73" - 84" (07)	85" - 96" (08)	97" - 108" (09)	109" - 120" (10)	121" - 132" (11)	133" - 144" (12)	145" - 156" (13)
Price	\$647.77	\$658.77	\$669.77	\$680.77	\$691.77	\$702.77	\$713.77	\$724.77
Size (Code)	157" - 168" (14)	169" - 180" (15)	181" - 192" (16)	193" - 204" (17)	205" - 216" (18)	217" - 228" (19)	229" - 240" (20)	241" - 252" (21)
Price	\$741.27	\$757.77	\$774.27	\$807.27	\$840.27	\$873.27	\$906.27	\$939.27

Parts

Item Picture							
Price	\$394.42	\$3.92 ft	\$2.30 ft	\$15.92	\$5.90	\$0.37	\$1.36
Item Picture							
Price	\$0.91	\$34.51	\$46.06	\$0.92	\$0.74	\$0.56	\$0.54



Tubular Motor Assembling Set

Model: Ali - DT8450(045)

AC Motor: Max. Capacity: Up to 125 lbs

Built-in Receiver

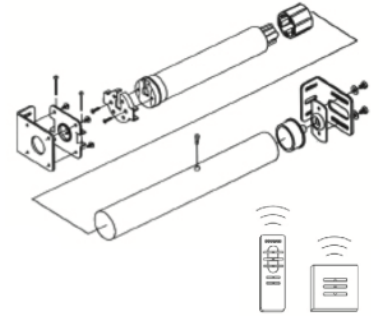
Assembling Drawing

Item #

90-4508-XX (Item Code): DT8550A-08/20, 72 bls











90-4512-XX (Item Code): DT8550B-12/26, 96 bls

90-4515-XX (Item Code): DT8550C-15/20, 125 bls



Item Code	Size	DT8550A-08/20	DT8550B-12/26	DT8550C-15/20
04	Up to 48"	\$395.11	\$439.07	\$494.07
05	49" - 60"	\$400.57	\$444.57	\$499.57
06	61" - 72"	\$411.57	\$455.57	\$510.57
07	73" - 84"	\$417.07	\$461.07	\$516.07
08	85" - 96"	\$428.07	\$472.07	\$527.07
09	97" - 108"	\$443.85	\$487.85	\$542.85
10	109" - 120"	\$461.45	\$503.25	\$558.25
11	121" - 132"	\$472.73	\$524.43	\$579.43
12	133" - 144"	\$494.73	\$546.43	\$601.43
13	145" - 156"	\$516.73	\$568.43	\$623.43
14	157" - 168"	\$538.73	\$589.33	\$654.43

Parts

Item Picture						
	90-8450A	90-8450B	90-8450C	90-3503	90-3504	90-3505
Price	\$218.77	\$251.77	\$275.88	\$3.48 ft	\$3.52	\$11.88
Item Picture						
	90-3506	90-1326	90-2518	90-3508	90-3509	90-3510
Price	\$14.97	\$32.87	\$3.25	\$21.95	\$21.95	\$21.95



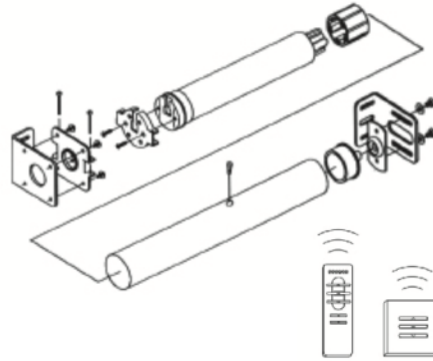
Tubular Motor Assembling Set

Model: Janet - DT8400 (035)

AC Motor: Max. Capacity: Up to 100 lbs

Built-in Receiver

Assembling Drawing



Item # 90-4006-XX (Item Code) : DT8400 A-6/28

Item Code	Size	DT8400 A-6/28
04	Up to 48"	\$286.01
05	49" - 60"	\$297.01
06	61" - 72"	\$308.02
07	73" - 84"	\$319.02
08	85" - 96"	\$330.03

Roller Shade More Than 8' -Using DT8450 (045) Recommended

Roman Shade: Tube Every 6 ft, Need Connecting Bracket To Support - Preventing Sagging Tube

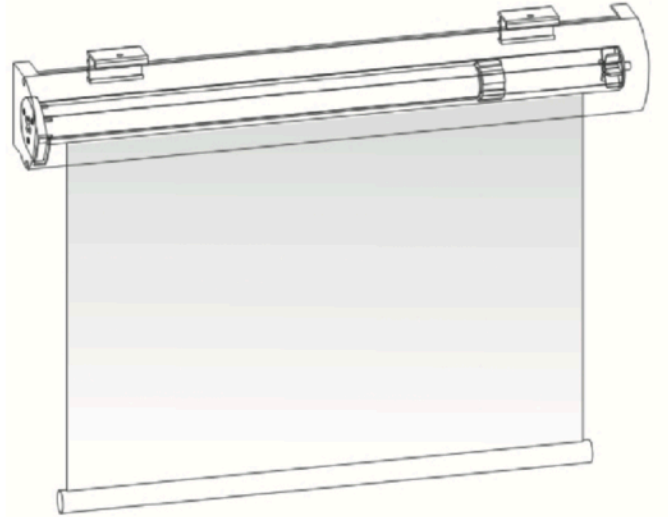
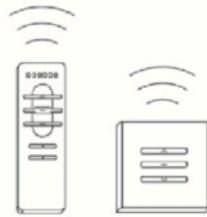
Parts

Item Picture						
Price	\$157.21					
Item Picture						
	90-3506	90-1326	90-2518	90-3503	90-3504	90-3505
Price	\$14.97	\$32.87	\$3.25	\$3.48 ft	\$3.52	\$11.88



Tubular Motor Assembling Set

Model: Sonata - DT8250 (025)
 DC Motor: Max. Capacity: 15 lbs
 Recharger Lithium Battery
 Built-in Receiver



Applied For Shade

Item #: 90-2502-XX (Item Code)

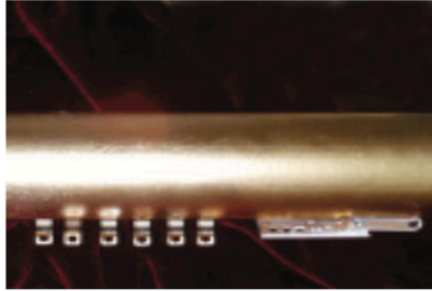
Size (Code)	Up to 24" (02)	25" - 36" (03)	37" - 48" (08)	49" - 60" (09)	61" - 72" (10)	73" - 84" (10)
Price	\$268.38	\$277.18	\$285.98	\$294.78	\$303.58	\$328.77

Parts

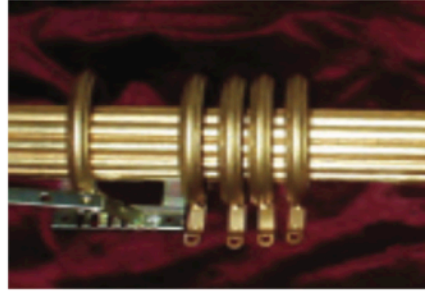
Item Picture	90-8250	90-2501	85-3503	88-3504	88-3505	85-3506	90-1326
Price	\$218.77	\$16.72	\$2.18 ft	\$2.60	\$2.77	\$5.02	\$32.87



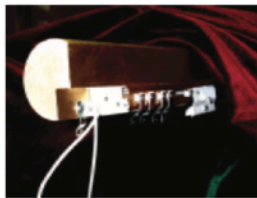
1-3/8" Wood Pole Cord Traverse Sets



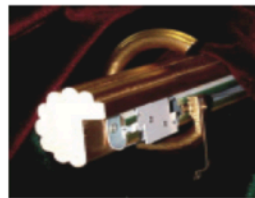
73-560



73-740



Slide Carriers



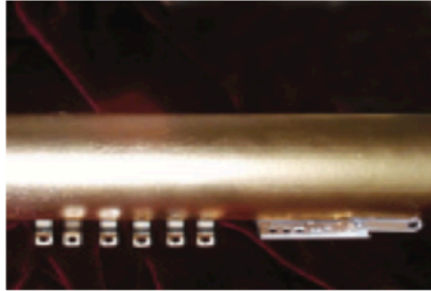
Molded Rings

Illustration	Item #	Finish	Description	1 st 6 ft	Add per feet
1-3/8" Wood Pole Traverse Set with "Slide Carriers" with standard brackets and finials					
<p>73-540</p>	73-540	19	1-3/8" Fluted Pole	\$95.22 set	\$8.96 ft
		C		\$125.58 set	\$12.42 ft
<p>73-560</p>	73-560	19	1-3/8" Plain Pole	\$95.22 set	\$8.96 ft
		C		\$125.58 set	\$12.42 ft
1-3/8" Wood Pole Traverse Set with "Molded Rings" with standard brackets and finials					
<p>73-740</p>	73-740	19	1-3/8" Fluted Pole	\$117.30 set	\$11.04 ft
		C		\$147.66 set	\$12.42 ft
<p>73-760</p>	73-760	19	1-3/8" Plain Pole	\$117.30 set	\$11.04 ft
		C		\$147.66 set	\$12.42 ft

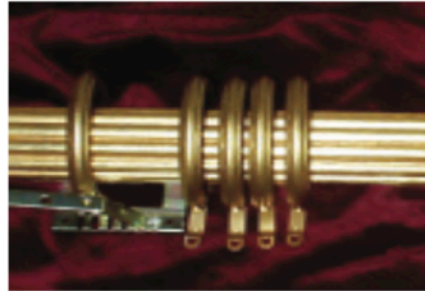
Color No. 19: Unfinished, C: Custom Color



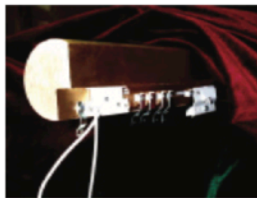
2" Wood Pole Cord Traverse Sets



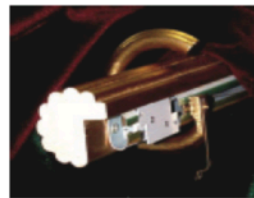
74-560



74-740



Slide Carriers



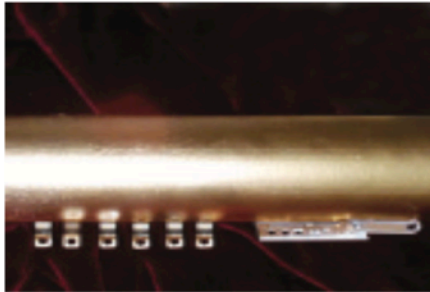
Molded Rings

Illustration	Item #	Finish	Description	1 st 6 ft	Add per feet
2" Wood Pole Traverse Set with "Slide Carriers" with standard brackets and finials					
	74-540	19	2" Fluted Pole	\$134.89 set	\$10.00 ft
		C		\$165.60 set	\$13.38 ft
	74-560	19	2" Plain Pole	\$134.89 set	\$10.00 ft
		C		\$165.60 set	\$13.38 ft
2" Wood Pole Traverse Set with "Molded Rings" with standard brackets and finials					
	74-740	19	2" Fluted Pole	\$162.41 set	\$12.76 ft
		C		\$205.27 set	\$18.97 ft
	74-760	19	2" Plain Pole	\$162.41 set	\$12.76 ft
		C		\$205.27 set	\$18.97 ft

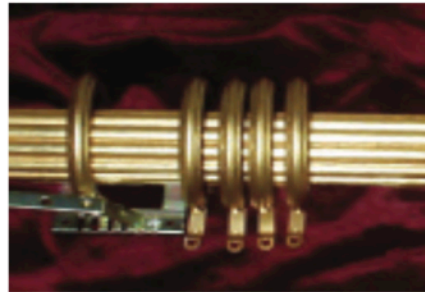
Color No. 19: Unfinished, C: Custom Color



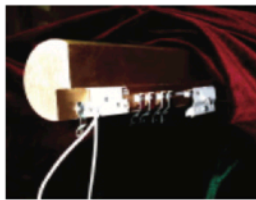
2-1/4" Wood Pole Cord Traverse Sets



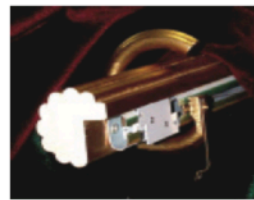
75-560



75-740



Slide Carriers



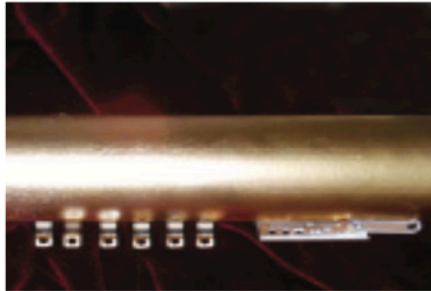
Molded Rings

Illustration	Item #	Finish	Description	1 st 6 ft	Add per feet
2-1/4" Wood Pole Traverse Set with "Slide Carriers" with standard brackets and finials					
	75-540	19	2-1/4" Fluted Pole	\$147.55 set	\$11.72 ft
		C		\$189.06 set	\$14.48 ft
	75-560	19	2-1/4" Plain Pole	\$147.55 set	\$11.72 ft
		C		\$189.06 set	\$14.48 ft
2-1/4" Wood Pole Traverse Set with "Molded Rings" with standard brackets and finials					
	75-740	19	2-1/4" Fluted Pole	\$186.30 set	\$14.48 ft
		C		\$229.08 set	\$20.21 ft
	75-760	19	2-1/4" Plain Pole	\$186.30 set	\$14.48 ft
		C		\$229.08 set	\$20.21 ft

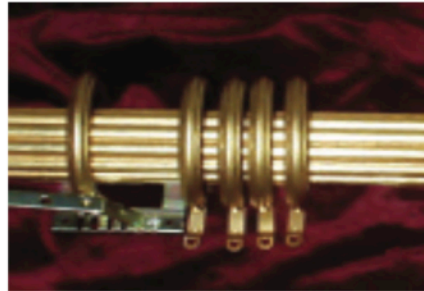
Color No. 19: Unfinished, C: Custom Color



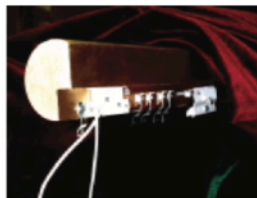
3" Wood Pole Cord Traverse Sets



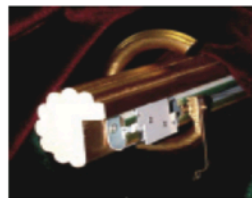
76-560



76-740



Slide Carriers



Molded Rings

Illustration	Item #	Finish	Description	1 st 6 ft	Add per feet
3" Wood Pole Traverse Set with "Slide Carriers" with standard brackets and finials					
	76-540	19	3" Fluted Pole	\$207.00 set	\$16.56 ft
		C		\$274.56 set	\$22.76 ft
	76-560	19	3" Plain Pole	\$207.00 set	\$16.56 ft
		C		\$274.56 set	\$22.76 ft
3" Wood Pole Traverse Set with "Molded Rings" with standard brackets and finials					
	76-740	19	3" Fluted Pole	\$305.10 set	\$23.93 ft
		C		\$381.00 set	\$31.99 ft
	76-760	19	3" Plain Pole	\$305.10 set	\$23.93 ft
		C		\$381.00 set	\$31.99 ft

Color No. 19: Unfinished, C: Custom Color

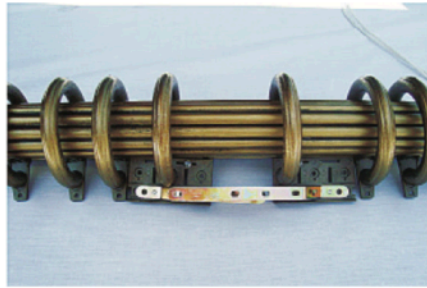


Traverse Wood (All Custom - Cut to Measure)

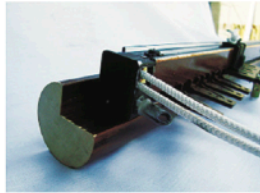
2" Wood Pole Cord Traverse With Ball Bearing Carrier With Aluminum Track (9001)



74-660



74-840



Slide Carriers



Molded Rings

Illustration	Item #	Finish	Description	1 st 6 ft	Add per feet
2" Ball Bearing Carries/Aluminum Track (9001) with standard brackets and finials					
 74-640	74-640	19	2" Fluted Pole	\$176.29 set	\$13.79 ft
		C		\$224.76 set	\$17.88 ft
 74-660	74-660	19	2" Plain Pole	\$176.29 set	\$13.79 ft
		C		\$224.76 set	\$17.88 ft
2" Molded Rings/Aluminum Track (9001) with standard brackets and finials					
 74-840	74-840	19	2" Fluted Pole	\$235.34 set	\$18.62 ft
		C		\$281.32 set	\$21.60 ft
 74-860	74-860	19	2" Plain Pole	\$235.34 set	\$18.62 ft
		C		\$281.32 set	\$21.60 ft

Color No. 19: Unfinished, C: Custom Color

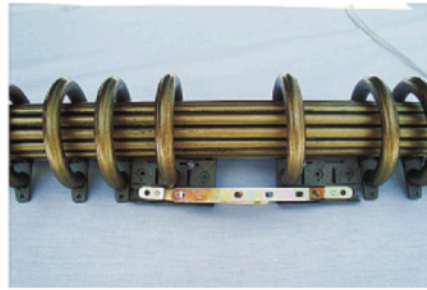


Traverse Wood (All Custom - Cut to Measure)

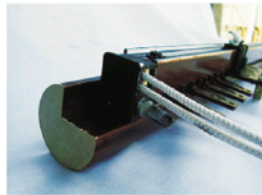
2-1/4" Wood Pole Cord Traverse With Ball Bearing Carrier With Aluminum Track (9001)



75-660



75-840



Slide Carriers



Molded Rings

Illustration	Item #	Finish	Description	1 st 6 ft	Add per feet
2-1/4" Ball Bearing Carries/Aluminum Track (9001) with standard brackets and finials					
	75-640	19	2-1/4" Fluted Pole	\$200.10 set	\$14.48 ft
		C		\$230.46 set	\$17.24 ft
	75-660	19	2-1/4" Plain Pole	\$200.10 set	\$14.48 ft
		C		\$230.46 set	\$17.24 ft
2-1/4" Molded Rings/Aluminum Track (9001) with standard brackets and finials					
	75-840	19	2-1/4" Fluted Pole	\$241.50 set	\$18.97 ft
		C		\$284.28 set	\$22.01 ft
	75-860	19	2-1/4" Plain Pole	\$241.50 set	\$18.97 ft
		C		\$284.28 set	\$22.01 ft

Color No. 19: Unfinished, C: Custom Color

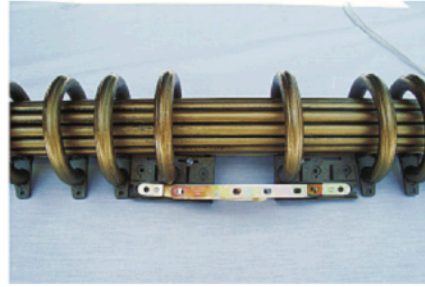


Traverse Wood (All Custom - Cut to Measure)

3" Wood Pole Cord Traverse With Ball Bearing Carrier With Aluminum Track (9001)



76-660



76-840



Slide Carriers



Molded Rings

Illustration	Item #	Finish	Description	1 st 6 ft	Add per feet
3" Ball Bearing Carries/Aluminum Track (9001) with standard brackets and finials					
	76-640	19	3" Fluted Pole	\$248.40 set	\$19.32 ft
		C		\$306.36 set	\$25.52 ft
	76-660	19	3" Plain Pole	\$248.40 set	\$19.32 ft
		C		\$306.36 set	\$25.52 ft
3" Molded Rings/Aluminum Track (9001) with standard brackets and finials					
	76-840	19	3" Fluted Pole	\$360.42 set	\$28.07 ft
		C		\$436.20 set	\$37.06 ft
	76-860	19	3" Plain Pole	\$360.42 set	\$28.07 ft
		C		\$436.20 set	\$37.06 ft

Color No. 19: Unfinished, C: Custom Color



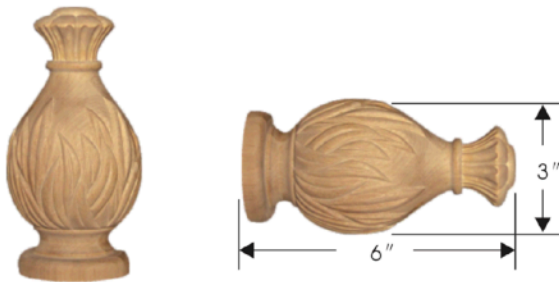
Wooden Finials For 2" and 2-1/4" Pole



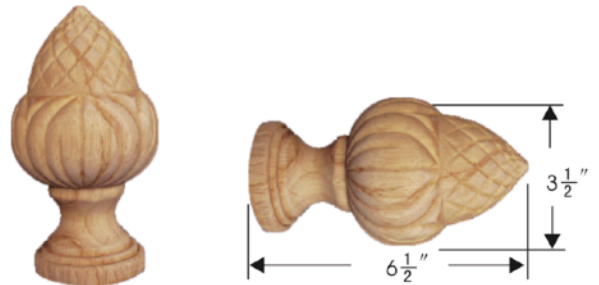
20-8724 Corinthian



20-8733 Fiji



20-8726 Pampia



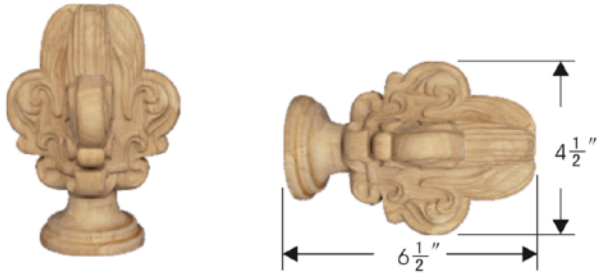
20-8715 Deco Acorn

Item No	Color	Description	Full Pack		Broken Pack
			Q'ty	Price	
20-8724	19	Corinthian	10 ea	\$15.75	\$18.80
	28, 83			\$17.75	\$21.70
	62, 73			\$19.25	\$23.70
20-8733	19	Fiji	10 ea	\$14.25	\$16.50
	28, 83			\$16.45	\$19.75
	62, 73			\$18.45	\$22.15
20-8726	19	Pampia	10 ea	\$14.25	\$16.50
	28, 83			\$16.45	\$19.75
	62, 73			\$18.45	\$22.25
20-8715	19	Deco Acorn	10 ea	\$14.25	\$16.50
	28, 83			\$16.45	\$19.75
	62, 73			\$18.45	\$22.25

Color No: 19-Unfinished 28-Walnut 83-Mahogany 62-Antique Gold 73-White Gold
 Custom Color finishing charges are base on unfinished (color No 19) price plus \$7.50



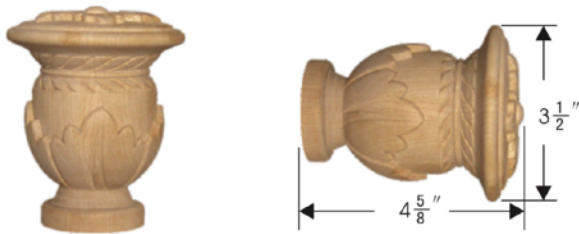
Wooden Finials For 2" and 2-1/4" Pole



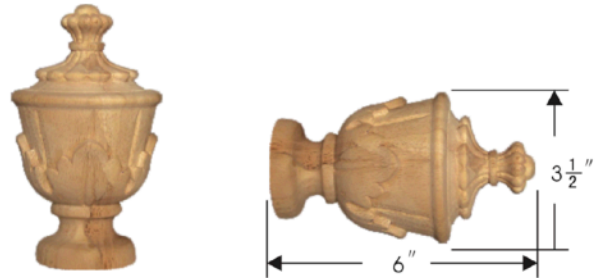
20-8728 Fleur De Lys



20-8734 Lisbon



20-8739 Pampu



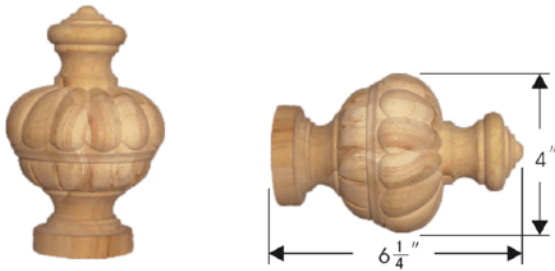
20-8730 Santana

Item No	Color	Description	Full Pack		Broken Pack
			Q'ty	Price	
20-8728	19	Fleur De Lys	10 ea	\$16.70	\$19.50
	28, 83			\$18.70	\$22.50
	62, 73			\$20.70	\$24.75
20-8734	19	Lisbon	10 ea	\$14.25	\$16.50
	28, 83			\$16.45	\$19.75
	62, 73			\$18.45	\$22.25
20-8739	19	Pampu	10 ea	\$15.65	\$18.50
	28, 83			\$17.75	\$21.30
	62, 73			\$19.75	\$23.70
20-8730	19	Santana	10 ea	\$15.65	\$18.50
	28, 83			\$17.75	\$21.30
	62, 73			\$19.75	\$23.70

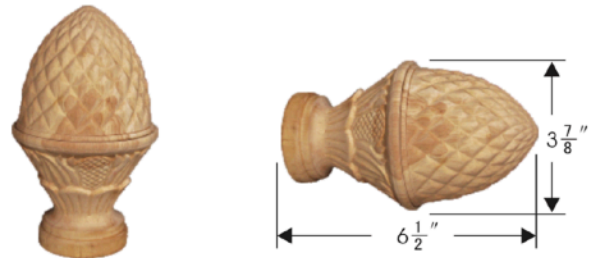
Color No: 19-Unfinished 28-Walnut 83-Mahogany 62-Antique Gold 73-White Gold
 Custom Color finishing charges are base on unfinished (color No 19) price plus \$7.50



Wooden Finials For 2" and 2-1/4" Pole



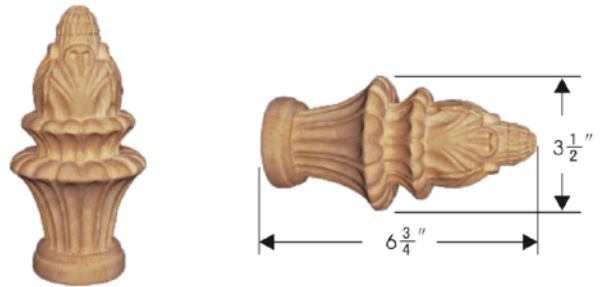
20-8736 Windsor



20-8711 Faceted Pine Cone



20-8732 Paris



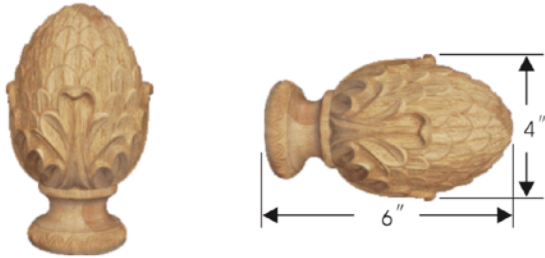
20-8716 Blooming Bud

Item No	Color	Description	Full Pack		Broken Pack
			Q'ty	Price	
20-8736	19	Windsor	10 ea	\$15.65	\$18.50
	28, 83			\$17.75	\$21.30
	62, 73			\$19.75	\$23.70
20-8711	19	Faceted Pine Cone	10 ea	\$15.65	\$18.50
	28, 83			\$17.75	\$21.30
	62, 73			\$19.75	\$23.70
20-8732	19	Paris	10 ea	\$14.25	\$16.50
	28, 83			\$16.45	\$19.75
	62, 73			\$18.45	\$22.25
20-8716	19	Blooming Bud	10 ea	\$14.25	\$16.50
	28, 83			\$16.45	\$19.75
	62, 73			\$18.45	\$22.25

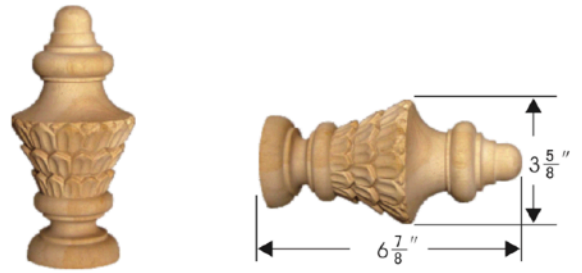
Color No: 19-Unfinished 28-Walnut 83-Mahogany 62-Antique Gold 73-White Gold
 Custom Color finishing charges are base on unfinished (color No 19) price plus \$7.50



Wooden Finials For 2" and 2-1/4" Pole



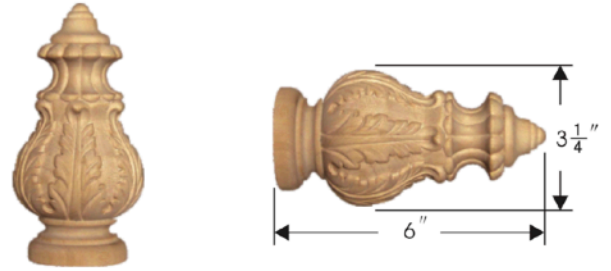
20-8722 Oak Leaf Cone



20-8738 Sonia



20-8729 Benega

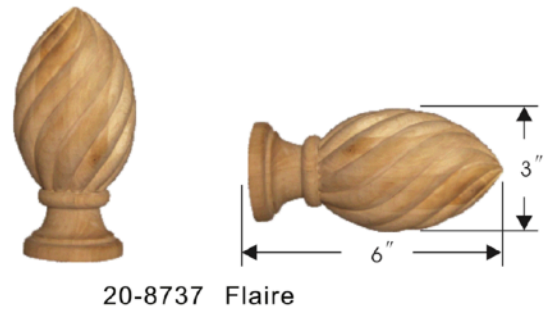
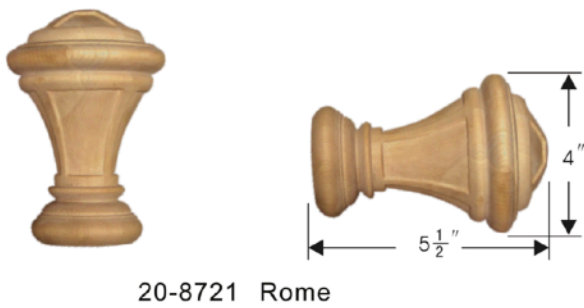
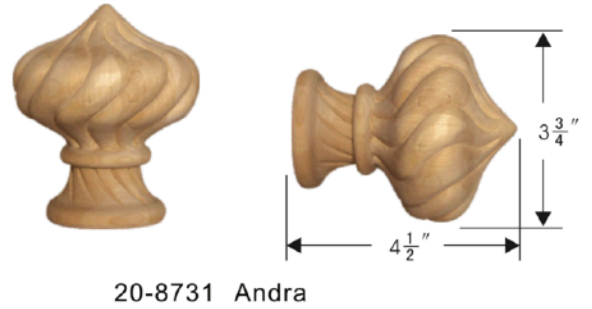
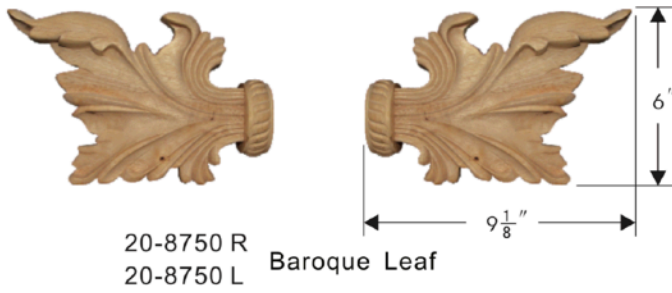


20-8735 Sandore

Item No	Color	Description	Full Pack		Broken Pack
			Q'ty	Price	
20-8722	19	Oak Leaf Cone	10 ea	\$14.25	\$16.50
	28, 83			\$16.45	\$19.75
	62, 73			\$18.45	\$22.25
20-8738	19	Sonia	10 ea	\$14.25	\$16.50
	28, 83			\$16.45	\$19.75
	62, 73			\$18.45	\$22.25
20-8729	19	Benega	10 ea	\$15.65	\$18.50
	28, 83			\$17.75	\$21.30
	62, 73			\$19.75	\$23.70
20-8735	19	Sandore	10 ea	\$15.65	\$18.50
	28, 83			\$17.75	\$21.30
	62, 73			\$19.75	\$23.70

Color No: 19-Unfinished 28-Walnut 83-Mahogany 62-Antique Gold 73-White Gold
 Custom Color finishing charges are base on unfinished (color No 19) price plus \$7.50

Wooden Finials For 2" and 2-1/4" Pole

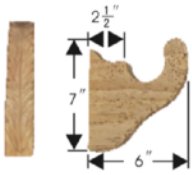


Item No	Color	Description	Full Pack		Broken Pack
			Q'ty	Price	
20-8750 R/L	19	Baroque Leaf	10 ea	\$16.70	\$19.25
	28, 83			\$18.70	\$22.50
	62, 73			\$20.70	\$24.85
20-8731	19	Andra	10 ea	\$14.25	\$16.50
	28, 83			\$16.45	\$19.75
	62, 73			\$18.45	\$22.25
20-8721	19	Rome	10 ea	\$14.25	\$16.50
	28, 83			\$16.45	\$19.75
	62, 73			\$18.45	\$22.25
20-8737	19	Flaire	10 ea	\$14.25	\$16.50
	28, 83			\$16.45	\$19.75
	62, 73			\$18.45	\$22.25

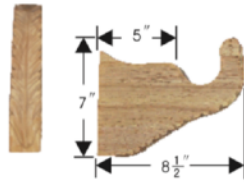
Color No: 19-Unfinished 28-Walnut 83-Mahogany 62-Antique Gold 73-White Gold
 Custom Color finishing charges are base on unfinished (color No 19) price plus \$7.50



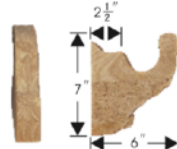
Wooden Brackets For 2" and 2-1/4" Pole



20-8703
Long Leaf



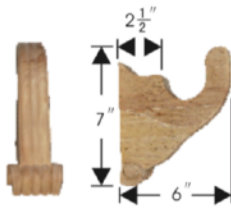
20-8705
Large Long Leaf



20-8780
Rosette Garland



20-8782
Large Rosette Garland



20-8784
Ribbed Ribbon



20-8786
Large Ribbed Ribbon

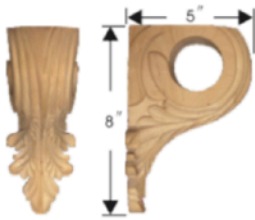
Item No	Color	Description	Full Pack		Broken Pack
			Q'ty	Price	
20-8703	19 28, 83 62, 73	Long Leaf	10 ea	\$15.40 \$17.50 \$19.50	\$18.48 \$21.00 \$23.40
20-8705	19 28, 83 62, 73	Large Long Leaf	10 ea	\$19.25 \$20.85 \$22.85	\$22.91 \$25.02 \$27.42
20-8780	19 28, 83 62, 73	Rosette Garland	10 ea	\$15.40 \$17.50 \$19.50	\$18.48 \$21.00 \$23.40
20-8782	19 28, 83 62, 73	Large Rosette Garland	10 ea	\$19.25 \$20.85 \$22.85	\$22.91 \$25.02 \$27.42
20-8784	19 28, 83 62, 73	Ribbed Ribbon	10 ea	\$15.40 \$17.50 \$19.50	\$18.48 \$21.00 \$23.40
20-8786	19 28, 83 62, 73	Large Ribbed Ribbon	10 ea	\$19.25 \$20.85 \$22.85	\$22.91 \$25.02 \$27.42

Color No: 19-Unfinished 28-Walnut 83-Mahogany 62-Antique Gold 73-White Gold
 Custom Color finishing charges are base on unfinished (color No 19) price plus \$7.50

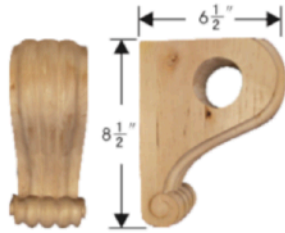


Decorative Wood Hand Carving

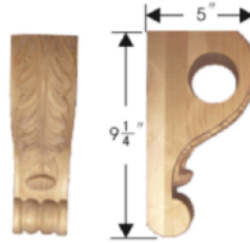
Scones for 2" and 2-1/4"



20-8106 Lisa



20-8102 Scroll



20-8104 Melina



20-8105 Sofia

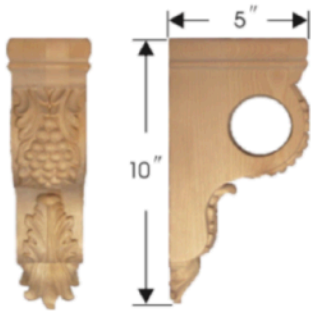
Item No	Color	Description	Full Pack		Broken Pack
			Q'ty	Price	
20-8105	19	Sofia	10 ea	\$28.15	\$37.75
	28, 83			\$31.65	\$38.95
	62, 73			\$33.65	\$40.25
20-8104	19	Melina	10 ea	\$25.35	\$30.50
	28, 83			\$28.85	\$34.50
	62, 73			\$30.85	\$37.02
20-8102	19	Scroll	10 ea	\$20.65	\$24.75
	28, 83			\$24.15	\$28.95
	62, 73			\$26.15	\$31.25
20-8106	19	Lisa	10 ea	\$20.85	\$25.00
	28, 83			\$24.35	\$29.25
	62, 73			\$26.35	\$31.50

Color No: 19-Unfinished 28-Walnut 83-Mahogany 62-Antique Gold 73-White Gold
 Custom Color finishing charges are base on unfinished (color No 19) price plus \$7.50



Decorative Wood Hand Carving

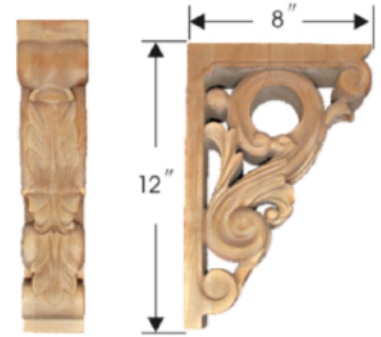
Scones for 2" and 2-1/4"



20-8103 Garbrille



20-8107 Madona

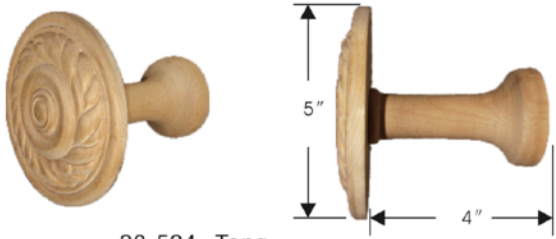


20-8101 Alexandra

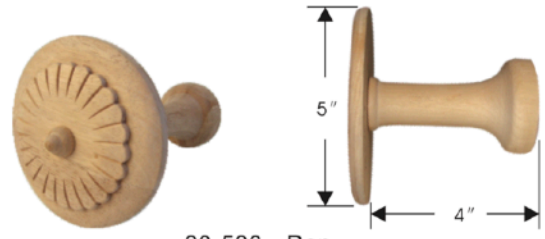
Item No	Color	Description	Full Pack		Broken Pack
			Q'ty	Price	
20-8107	19	Madona	10 ea	\$23.80	\$28.50
	28, 83			\$27.30	\$37.75
	62, 73			\$29.30	\$35.25
20-8101	19	Alexandra	10 ea	\$29.80	\$35.80
	28, 83			\$33.30	\$39.95
	62, 73			\$35.30	\$42.25
20-8103	19	Garbrille	10 ea	\$23.40	\$28.00
	28, 83			\$26.90	\$32.25
	62, 73			\$28.90	\$34.75

Color No: 19-Unfinished 28-Walnut 83-Mahogany 62-Antique Gold 73-White Gold
 Custom Color finishing charges are base on unfinished (color No 19) price plus \$7.50

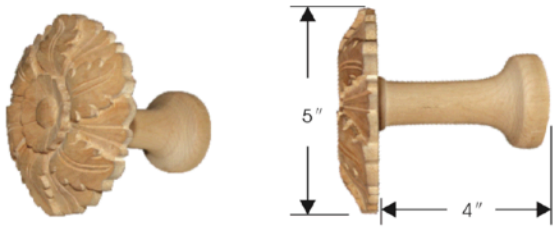
Tie Back Holders



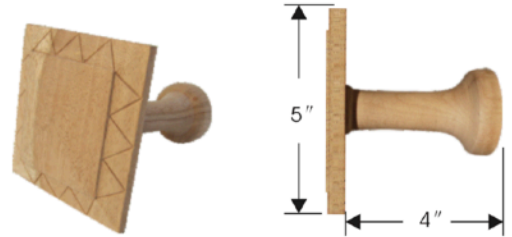
20-524 Tong



20-526 Ren



20-525 Leaf



20-527 Square

Item No	Color	Description	Full Pack		Broken Pack
			Q'ty	Price	
20-424	19	Tong	10 ea	\$13.95	\$16.68
	28, 83			\$16.15	\$19.35
	62, 73			\$18.15	\$21.75
20-426	19	Ren	10 ea	\$13.95	\$16.68
	28, 83			\$16.15	\$19.35
	62, 73			\$18.15	\$21.75
20-425	19	Leaf	10 ea	\$13.95	\$16.68
	28, 83			\$16.15	\$19.35
	62, 73			\$18.15	\$21.75
20-427	19	Square	10 ea	\$13.95	\$16.68
	28, 83			\$16.15	\$19.35
	62, 73			\$18.15	\$21.75

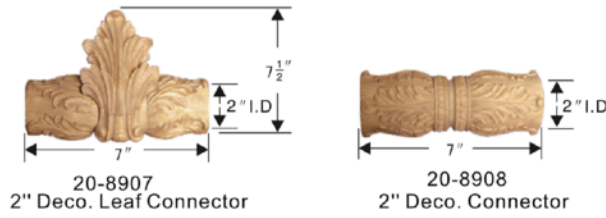
Color No: 19-Unfinished 28-Walnut 83-Mahogany 62-Antique Gold 73-White Gold
 Custom Color finishing charges are base on unfinished (color No 19) price plus \$7.50



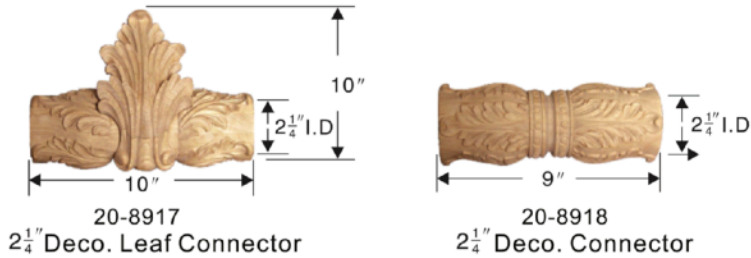
Decorative Wood Hand Carving

Decorative Scarf Holder

2" Deco.Connector



2 1/4" Deco.Connector



Item No	Color	Description	Full Pack		Broken Pack
			Q'ty	Price	
20-8907	19	2" I.D Deco Leaf Connector	5 ea	\$28.20	\$33.90
	28, 83			\$29.25	\$35.10
	62, 73			\$31.25	\$37.50
20-8908	19	2" I.D Leaf Connector	5 ea	\$25.98	\$30.98
	28, 83			\$27.10	\$32.50
	62, 73			\$29.10	\$34.90
20-8917	19	2-1/4" I.D Deco Leaf Connector	5 ea	\$41.50	\$49.00
	28, 83			\$42.50	\$51.00
	62, 73			\$45.50	\$54.60
20-8918	19	2-1/4" I.D Leaf Connector	5 ea	\$26.50	\$45.80
	28, 83			\$27.10	\$46.50
	62, 73			\$29.10	\$49.50

Color No: 19-Unfinished 28-Walnut 83-Mahogany 62-Antique Gold 73-White Gold
 Custom Color finishing charges are base on unfinished (color No 19) price plus \$7.50



Decorative Wood Hand Carving

Hand Carving Decorative Wooden Ring



20-8901
Rope



20-8902
Cross

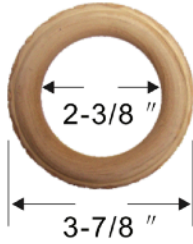


20-8903
Leaf

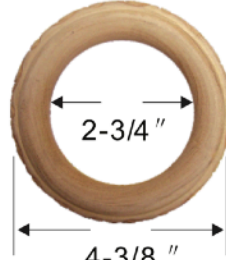


20-8904
Savoy

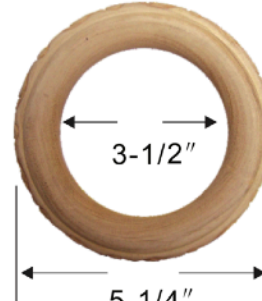
3 size available



for 2" pole



for 2-1/4" pole



for 3" pole

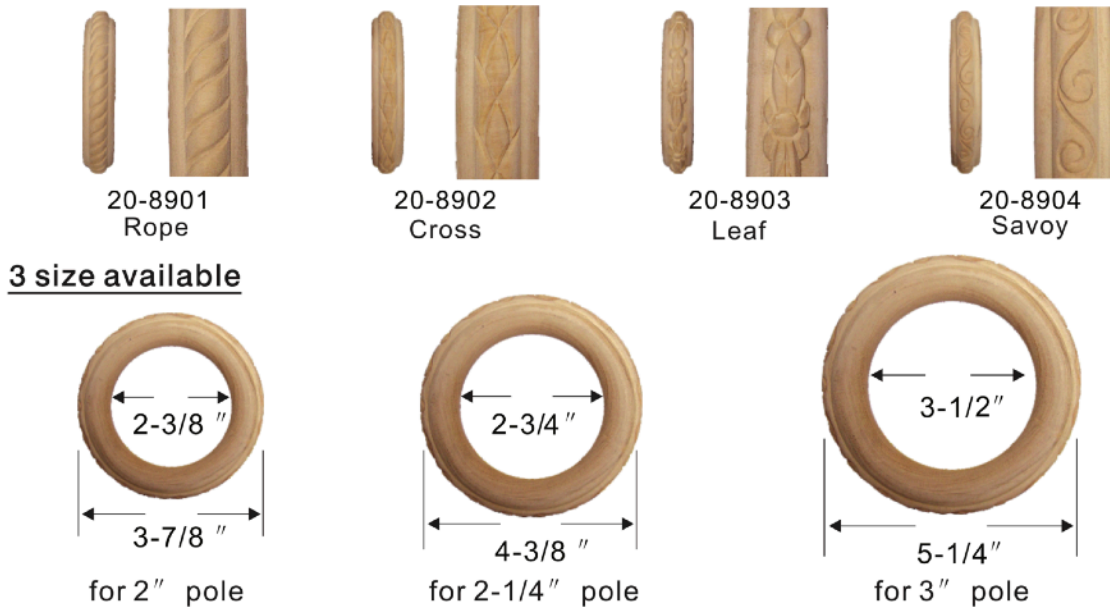
Item No	Color	Description	Full Pack		Broken Pack
			Q'ty	Price	
20-8901-4	19	Rope	20 ea	\$1.83	\$2.18
	28, 83			\$2.13	\$2.56
	62, 73			\$2.88	\$3.46
20-8901-4	19	Cross	20 ea	\$2.64	\$3.28
	28, 83			\$2.90	\$3.48
	62, 73			\$3.65	\$4.38
20-8901-6	19	Rope	20 ea	\$3.74	\$4.49
20-8901-6	28, 83			\$3.90	\$4.68
	62, 73			\$4.66	\$5.59
20-8902-4	19	Cross	20 ea	\$1.83	\$2.18
	28, 83			\$2.13	\$2.56
	62, 73			\$2.88	\$3.46
20-8902-4	19	Rope	20 ea	\$2.64	\$3.28
	28, 83			\$2.90	\$3.48
	62, 73			\$3.65	\$4.38
20-8902-6	19	Cross	20 ea	\$3.74	\$4.49
	28, 83			\$3.90	\$4.68
	62, 73			\$4.66	\$5.59

Color No: 19-Unfinished 28-Walnut 83-Mahogany 62-Antique Gold 73-White Gold
 Custom Color finishing charges are base on unfinished (color No 19) price plus \$7.50



Decorative Wood Hand Carving

Hand Carving Decorative Wooden Ring



Item No	Color	Description	Full Pack		Broken Pack	
			Q'ty	Price		
20-8903-4	19 28, 83 62, 73	Leaf	For 2" Pole	20 ea	\$2.25 \$2.54 \$3.29	\$2.70 \$3.05 \$3.95
			For 2-1/4" Pole	20 ea	\$2.97 \$3.20 \$3.95	\$3.56 \$3.84 \$4.74
			For 3" Pole	20 ea	\$5.05 \$5.23 \$5.98	\$6.08 \$6.28 \$7.18
20-8904-4	19 28, 83 62, 73	Savoy	For 2" Pole	20 ea	\$2.28 \$2.54 \$3.29	\$2.70 \$3.05 \$3.95
			For 2-1/4" Pole	20 ea	\$2.97 \$3.20 \$3.95	\$3.56 \$3.84 \$4.74
			For 3" Pole	20 ea	\$5.05 \$5.23 \$5.98	\$6.08 \$6.28 \$7.18

Color No: 19-Unfinished 28-Walnut 83-Mahogany 62-Antique Gold 73-White Gold
 Custom Color finishing charges are base on unfinished (color No 19) price plus \$7.50



Wood Pole Package Sets

1-3/8" Wood Pole Package Set

12' Plain or Fluted Wood Pole (40 Plain Rings, 3 European Brackets, 2 Ball Finials)

Item No	Finish	Description	Full Pack		Broken Pack
			Q'ty	Price	
62, 63, 73	28, 80, 83, 7	12' (6' x 2) Plain Wood Pole 40 Plain Wood Rings 3 European Brackets 2 Ball Finials	4 sets	\$40.54	\$48.64
	62, 63, 73		4 sets	\$44.61	\$53.52
3-24A-12	28, 80, 83, 7	12' (6' x 2) Plain Wood Pole 40 Plain Wood Rings 3 European Brackets 2 Ball Finials	4 sets	\$40.54	\$48.64
	62, 63, 73		4 sets	\$44.61	\$53.52

2" Wood Pole Package Set

12' Plain or Fluted Wood Pole (40 Plain Rings, 3 European Brackets, 2 Ball Finials)

Item No	Finish	Description	Full Pack		Broken Pack
			Q'ty	Price	
62, 63, 73	28, 80, 83, 7	12' (6' x 2) Plain Wood Pole 40 Plain Wood Rings 3 European Brackets 2 Ball Finials	4 sets	\$108.68	\$130.42
	62, 63, 73		4 sets	\$128.24	\$139.89
3-24A-12	28, 80, 83, 7	12' (6' x 2) Plain Wood Pole 40 Plain Wood Rings 3 European Brackets 2 Ball Finials	4 sets	\$108.68	\$130.42
	62, 63, 73		4 sets	\$128.24	\$139.89

Note: When ordering finished pole, specify color by adding color code after item no. (ex: 4-14A-12-7)

Color Code

19 : Unfinished	83 : Mahogany
7 : White	62 : Antique Gold
28 : Walnut	63 : Gold
80 : Oak	73 : White Gold



1" Wood Pole And Components

Illustration	Item No	Finish	Description	Full Pack		Broken Pack
				Q'ty	Price	
1" Wood Pole 2-14-19 2-24-19	2-14-12	19	Plain Pole 12'	6 pcs	\$19.60	\$25.41
		7, 28, 80, 83		6 pcs	\$24.54	\$28.90
	2-24-12	19	Fluted Pole 12'	6 pcs	\$19.60	\$25.41
		7, 28, 80, 83		6 pcs	\$24.54	\$28.90
Wood Bracket for 1" Pole 2-49-19	2-49	19	Wall Bracket 1-1/2" Projection	6 pcs	\$2.12	\$2.73
		7, 28, 80, 83		6 pcs	\$2.73	\$3.33
Wood Rings for 1" Pole 2-64-19	2-64	19	Plain Ring I.D 1-3/8" / O.D 2-1/4"	6 pcs	\$0.48	\$0.61
		7, 28, 80, 83		6 pcs	\$0.59	\$0.79
Wood Pole End for 1" Pole 2-72-19	2-72	19	Traditional Type	6 pcs	\$2.00	\$2.30
		7, 28, 80, 83		6 pcs	\$2.24	\$2.54
Wood Socket for 1" Pole 2-96-19	2-96	19	Wood Pole Socket 1 pr. Per bag	6 bags	\$1.87	\$2.23
		7, 28, 80, 83		6 bags	\$2.23	\$2.60

Note: When ordering finished pole, specify color by adding color code after item no. (ex: 2-14-12-7)

Color Code







19 : Unfinished
 7 : White
 28 : Walnut
 80 : Oak
 83 : Mahogany

Cut Size Guide for 1" Pole

\$2.00 ft Unfinished
\$2.50 ft Finished



1-3/8" Wood Pole And Components

Illustration	Item No	Finish	Description	Full Pack		Broken Pack
				Q'ty	Price	
1-3/8" Wood Pole  3-14-19  3-24-19	3-14-8	19 7, 28, 80, 83 62, 63, 73	Plain Pole 8'	6 pcs	\$14.04 \$17.91 \$21.12	\$18.88 \$21.78 \$25.71
	3-14-12	19 7, 28, 80, 83 62, 63, 73	Plain Pole 12'	6 pcs	\$21.05 \$26.86 \$31.70	\$28.31 \$32.62 \$38.56
	3-14-16	19 7, 28, 80, 83 62, 63, 73	Plain Pole 16'	6 pcs	\$31.94 \$39.69 \$46.83	\$41.62 \$47.43 \$52.35
	3-24-8	19 7, 28, 80, 83 62, 63, 73	Fluted Pole 8'	6 pcs	\$14.04 \$17.91 \$21.12	\$18.88 \$21.78 \$25.71
	3-24-12	19 7, 28, 80, 83 62, 63, 73	Fluted Pole 12'	6 pcs	\$21.05 \$26.86 \$31.70	\$28.31 \$32.62 \$38.56
	3-24-16	19 7, 28, 80, 83 62, 63, 73	Fluted Pole 16'	6 pcs	\$31.94 \$39.69 \$46.83	\$41.62 \$47.43 \$52.35
Wood Bracket for 1-3/8" Pole  3-50-19 3-50K-19  3-54-19 3-54K-19  3-55-19 3-51-19  3-59-19	3-49	19 7, 28, 80, 83 62, 63, 73	Wall Bracket 1-1/2" Projection	10 ea	\$2.84 \$3.34 \$4.06	\$3.33 \$4.06 \$4.79
	3-50	19 7, 28, 80, 83 62, 63, 73	Wall Bracket 3" Projection	20 ae	\$2.84 \$3.34 \$4.06	\$3.33 \$4.06 \$4.79
	3-50K	19 7, 28, 80, 83 62, 63, 73	Wall Bracket 3" Projection	20 ae	\$2.84 \$3.34 \$4.06	\$3.33 \$4.06 \$4.79
	3-54	19 7, 28, 80, 83 62, 63, 73	Wall Bracket w/Steel Plate 6" Projection	20 ae	\$5.98 \$6.95 \$8.22	\$6.84 \$7.87 \$9.66
	3-54K	19 7, 28, 80, 83 62, 63, 73	Wall Bracket w/Steel Plate 6" Projection	20 ae	\$5.98 \$6.95 \$8.22	\$6.84 \$7.87 \$9.66
	3-51	19 7, 28, 80, 83 62, 63, 73	European Wall Bracket 3" Projection	20 ae	\$3.56 \$4.41 \$5.20	\$3.56 \$4.41 \$5.20
	3-51K	19 7, 28, 80, 83 62, 63, 73	European Wall Bracket 3" Projection	20 ae	\$3.56 \$4.41 \$5.20	\$3.56 \$4.41 \$5.20
	3-55	19 7, 28, 80, 83 62, 63, 73	European Wall Bracket 6" Projection	20 ae	\$6.95 \$7.87 \$9.27	\$7.87 \$8.95 \$11.08
	3-53	19 7, 28, 80, 83 62, 63, 73	Center Support Bracket 3" Projection	10 ea	\$3.03 \$3.63 \$4.41	\$4.24 \$4.84 \$5.72
	3-59	19 7, 28, 80, 83 62, 63, 73	Ceiling Bracket 3" Projection	10 ea	\$4.53 \$5.45 \$6.42	\$5.75 \$6.66 \$7.87

Note: When ordering finished pole, specify color by adding color code after item no. (ex: 2-14-12-7)



1-3/8" Wood Pole And Components

Illustration	Item No	Finish	Description	Full Pack		Broken Pack
				Q'ty	Price	
Wood Rings for 1-3/8" Pole 	3-63	19 7, 28, 80, 83 62, 63, 73	Fluted Wood Ring I.D 1-7/8" O.D 2-7/8"	100 ea	\$0.64 \$0.72 \$0.85	\$0.76 \$0.84 \$0.99
	3-64	19 7, 28, 80, 83 62, 63, 73	Plain Wood Ring I.D 1-7/8" O.D 2-7/8"	100 ea	\$0.58 \$0.67 \$0.79	\$0.70 \$0.79 \$0.94
Wood Pole Ends for 1-3/8" Pole 	3-70	19 7, 28, 80, 83 62, 63, 73	End Cap	10 ae	\$2.12 \$2.37 \$2.78	\$2.37 \$2.61 \$3.08
	3-72	19 7, 28, 80, 83 62, 63, 73	Traditional Type	20 ae	\$2.12 \$2.37 \$2.78	\$2.37 \$2.61 \$3.08
	3-73	19 7, 28, 80, 83 62, 63, 73	Sherwood Type	20 ae	\$2.12 \$2.37 \$2.78	\$2.37 \$2.61 \$3.08
	3-75	19 7, 28, 80, 83 62, 63, 73	Ball Type	20 ae	\$2.12 \$2.37 \$2.78	\$2.37 \$2.61 \$3.08
	3-78	19 7, 28, 80, 83 62, 63, 73	Acorn Wood	20 ae	\$2.12 \$2.37 \$2.78	\$2.37 \$2.61 \$3.08
	3-62	19 7, 28, 80, 83 62, 63, 73	Wood Pole Elbow 3" x 6"	20 ae	\$3.94 \$4.73 \$5.68	\$4.84 \$5.81 \$6.97
Wood Sockets for 1-3/8" Pole 	3-88	19 7, 28, 80, 83 62, 63, 73	Wood Swivel Socket (Adjustable Corner)	5 ea	\$9.50 \$11.50 \$12.54	\$11.00 \$13.75 \$15.13
	3-96	19 7, 28, 80, 83 62, 63, 73	Wood Pole Socket 1 pr. Per bag	10 bags	\$2.37 \$3.09 \$3.58	\$3.03 \$3.58 \$4.18

Note: When ordering finished pole, specify color by adding color code after item no. (ex: 3-75-7)

Color Code

19 : Unfinished 83 : Mahogany
 7 : White 62 : Antique Gold
 28 : Walnut 63 : Gold
 80 : Oak 73 : White Gold

Cut Size Guide for 1" Pole

\$2.59 ft Unfinished
\$3.03 ft Finished
\$3.56 ft Gold Finished



2" Wood Pole And Components

Illustration	Item No	Finish	Description	Full Pack		Broken Pack
				Q'ty	Price	
2" Wood Pole 4-14-19 4-24-19 4-34-19	4-14-8	19 7, 28, 80, 83 62, 63, 73	Plain Pole 8'	2 pcs	\$38.72 \$42.59 \$50.27	\$48.40 \$53.24 \$62.83
	4-14-12	19 7, 28, 80, 83 62, 63, 73	Plain Pole 12'	2 pcs	\$58.08 \$63.91 \$75.38	\$72.60 \$79.86 \$94.24
	4-14-16	19 7, 28, 80, 83 62, 63, 73	Plain Pole 16'	2 pcs	\$85.18 \$92.93 \$109.66	\$106.48 \$117.13 \$138.22
	4-24-8	19 7, 28, 80, 83 62, 63, 73	Fluted Pole 8'	2 pcs	\$38.72 \$42.59 \$50.27	\$48.40 \$53.24 \$62.83
	4-24-12	19 7, 28, 80, 83 62, 63, 73	Fluted Pole 12'	2 pcs	\$58.08 \$63.91 \$75.38	\$72.60 \$79.86 \$94.24
	4-24-16	19 7, 28, 80, 83 62, 63, 73	Fluted Pole 16'	2 pcs	\$85.18 \$92.93 \$109.66	\$106.48 \$117.13 \$138.22
	4-34-8	19	Twisted Wood Pole 8'	2 pcs	\$96.80	\$116.16
	4-34-12	19	Twisted Wood Pole 12'	2 pcs	\$145.20	\$174.24
Wood Bracket for 2" Pole 4-50-19 4-50K-19 4-54-19 4-54K-19 4-55-19 4-51-19 4-59-19	4-50	19 7, 28, 80, 83 62, 63, 73	Wall Bracket 3" Projection	10 ae	\$6.13 \$6.36 \$4.92	\$7.87 \$8.17 \$10.27
	4-50K	19 7, 28, 80, 83 62, 63, 73	Wall Bracket 3" Projection	10 ae	\$6.13 \$6.36 \$4.92	\$7.87 \$8.17 \$10.27
	4-54	19 7, 28, 80, 83 62, 63, 73	Wall Bracket w/Steel Plate 6" Projection	10 ae	\$7.89 \$8.56 \$10.42	\$10.55 \$11.15 \$13.24
	4-54K	19 7, 28, 80, 83 62, 63, 73	Wall Bracket w/Steel Plate 6" Projection	10 ae	\$7.89 \$8.56 \$10.42	\$10.55 \$11.15 \$13.24
	4-51	19 7, 28, 80, 83 62, 63, 73	European Wall Bracket 3" Projection	20 ae	\$7.02 \$7.62 \$9.00	\$8.95 \$9.38 \$11.08
	4-55	19 7, 28, 80, 83 62, 63, 73	European Wall Bracket 6" Projection	20 ae	\$8.35 \$8.95 \$10.57	\$10.16 \$11.13 \$12.56
	4-53	19 7, 28, 80, 83 62, 63, 73	Center Support Bracket 3" Projection	10 ea	\$7.62 \$8.23 \$9.71	\$9.56 \$9.99 \$11.79
	4-59	19 7, 28, 80, 83 62, 63, 73	Ceiling Bracket 3" Projection	10 ea	\$8.17 \$9.44 \$11.13	\$9.08 \$10.65 \$12.56

Note: When ordering finished pole, specify color by adding color code after item no. (ex: 4-14-12-7)



2" Wood Pole And Components

Illustration	Item No	Finish	Description	Full Pack		Broken Pack
				Q'ty	Price	
	4-63	19 7, 28, 80, 83 62, 63, 73	Fluted Wood Ring I.D 2-3/8" O.D 3-7/8"	40 ae	\$1.16 \$1.40 \$1.54	\$1.40 \$1.64 \$1.93
	4-64	19 7, 28, 80, 83 62, 63, 73	Plain Wood Ring I.D 2-3/8" O.D 3-7/8"	40 ea	\$1.03 \$1.16 \$1.35	\$1.28 \$1.40 \$1.65
	4-66	19 7, 28, 80, 83 62, 63, 73	Plain Wood Ring I.D 2-1/4" O.D 3-1/2"	40 ea	\$0.91 \$1.03 \$1.21	\$1.16 \$1.28 \$1.50
	4-67	19 7, 28, 80, 83 62, 63, 73	Plain Wood Ring I.D 2-1/4" O.D 3-1/4"	40 ea	\$0.79 \$0.91 \$1.08	\$1.03 \$1.16 \$1.35
	4-70	19 7, 28, 80, 83 62, 63, 73	End Cap	10 ae	\$8.09 \$8.69 \$10.25	\$9.30 \$10.02 \$11.83
	4-73	19 7, 28, 80, 83 62, 63, 73	Sherwood Type	10 ae	\$8.09 \$8.69 \$10.25	\$9.30 \$10.02 \$11.83
	4-74	19 7, 28, 80, 83 62, 63, 73	Classic Type	10 ae	\$8.09 \$8.69 \$10.25	\$9.30 \$10.02 \$11.83
	4-75	19 7, 28, 80, 83 62, 63, 73	Ball Type	10 ae	\$8.09 \$8.69 \$10.25	\$9.30 \$10.02 \$11.83
	4-78	19 7, 28, 80, 83 62, 63, 73	Acorn Wood	10 ae	\$8.09 \$8.69 \$10.25	\$9.30 \$10.02 \$11.83
		4-62	19	Wood Pole Elbow 3" x 6"	10 ae	\$7.62
4-88		19 7, 28, 80, 83 62, 63, 73	Wood Swivel Socket (Adjustable Corner)	5 ea	\$11.92 \$14.34 \$15.68	\$13.31 \$16.34 \$18.10
4-96		19 7, 28, 80, 83 62, 63, 73	Wood Pole Socket 1 pr. Per bag	10 bags	\$7.62 \$8.83 \$10.29	\$9.50 \$11.08 \$12.89

Note: When ordering finished pole, specify color by adding color code after item no. (ex: 4-75-7)

Color Code







19 : Unfinished 83 : Mahogany
 7 : White 62 : Antique Gold
 28 : Walnut 63 : Gold
 80 : Oak 73 : White Gold

Cut Size Guide for 1" Pole

\$6.05 ft Unfinished
\$6.60 ft Finished
\$7.79 ft Gold Finished



2-1/4" Wood Pole And Components

Illustration	Item No	Finish	Description	Full Pack		Broken Pack
				Q'ty	Price	
2-1/4" Wood Pole  5-14-19  5-24-19  5-34-19	5-14-8	19 7, 28, 80, 83 62, 63, 73	Plain Pole 8'	2 pcs	\$50.34 \$55.18 \$65.12	\$60.02 \$64.86 \$76.54
	5-14-12	19 7, 28, 80, 83 62, 63, 73	Plain Pole 12'	2 pcs	\$75.50 \$79.46 \$97.67	\$90.02 \$97.28 \$114.81
	5-14-16	19 7, 28, 80, 83 62, 63, 73	Plain Pole 16'	2 pcs	\$100.67 \$110.35 \$130.23	\$120.03 \$135.52 \$159.92
	5-24-8	19 7, 28, 80, 83 62, 63, 73	Fluted Pole 8'	2 pcs	\$50.34 \$55.18 \$65.12	\$60.02 \$64.86 \$76.54
	5-24-12	19 7, 28, 80, 83 62, 63, 73	Fluted Pole 12'	2 pcs	\$75.50 \$79.46 \$97.67	\$90.02 \$97.28 \$114.81
	5-24-16	19 7, 28, 80, 83 62, 63, 73	Fluted Pole 16'	2 pcs	\$100.67 \$110.35 \$130.23	\$120.03 \$135.52 \$159.92
	5-34-8	19	Twisted Wood Pole 8'	2 pcs	\$116.16	\$145.20
	5-34-12	19	Twisted Wood Pole 12'	2 pcs	\$174.24	\$217.80
Wood Bracket for 2-1/4" Pole  5-50-19 5-54-19  5-55-19 5-51-19  5-59-19	5-50	19 7, 28, 80, 83 62, 63, 73	Wall Bracket 3" Projection	10 ae	\$7.02 \$7.62 \$9.00	\$8.95 \$9.38 \$11.08
	5-54	19 7, 28, 80, 83 62, 63, 73	Wall Bracket 6" Projection	10 ae	\$8.35 \$9.08 \$10.57	\$10.16 \$11.13 \$13.15
	5-51	19 7, 28, 80, 83 62, 63, 73	European Wall Bracket 3" Projection	20 ae	\$8.35 \$9.08 \$10.57	\$10.16 \$11.13 \$13.15
	5-55	19 7, 28, 80, 83 62, 63, 73	European Wall Bracket 6" Projection	20 ae	\$9.56 \$10.29 \$12.14	\$11.37 \$11.92 \$14.07
	5-53	19 7, 28, 80, 83 62, 63, 73	Center Support Bracket 3" Projection	10 ea	\$7.62 \$8.23 \$9.71	\$9.56 \$9.99 \$11.79
	5-59	19 7, 28, 80, 83 62, 63, 73	Ceiling Bracket 3" Projection	10 ea	\$9.08 \$9.99 \$11.79	\$10.59 \$11.50 \$13.56

Note: When ordering finished pole, specify color by adding color code after item no. (ex: 5-14-12-7)



2-1/4" Wood Pole And Components

Illustration	Item No	Finish	Description	Full Pack		Broken Pack
				Q'ty	Price	
	5-63	19 7, 28, 80, 83 62, 63, 73	Fluted Wood Ring I.D 2-3/4" O.D 4-3/8"	20 ae	\$1.82 \$2.12 \$2.51	\$2.12 \$2.37 \$2.78
	5-64	19 7, 28, 80, 83 62, 63, 73	Plain Wood Ring I.D 2-3/4" O.D 4-3/8"	20 ae	\$1.82 \$2.12 \$2.51	\$2.12 \$2.37 \$2.78
	5-66	19 7, 28, 80, 83 62, 63, 73	Plain Wood Ring I.D 2-3/4" O.D 4"	40 ea	\$1.16 \$1.28 \$1.51	\$1.40 \$1.52 \$1.79
	5-67	19 7, 28, 80, 83 62, 63, 73	Plain Wood Ring I.D 2-3/4" O.D 3-3/4"	40 ea	\$0.91 \$1.03 \$1.21	\$1.16 \$1.28 \$1.51
	5-70	19 7, 28, 80, 83 62, 63, 73	End Cap	10 ae	\$10.29 \$11.50 \$13.57	\$12.71 \$14.52 \$17.14
	5-73	19 7, 28, 80, 83 62, 63, 73	Sherwood Type	10 ae	\$10.29 \$11.50 \$13.57	\$12.71 \$14.52 \$17.14
	5-74	19 7, 28, 80, 83 62, 63, 73	Classic Type	10 ae	\$10.29 \$11.50 \$13.57	\$12.71 \$14.52 \$17.14
	5-75	19 7, 28, 80, 83 62, 63, 73	Ball Type	10 ae	\$10.29 \$11.50 \$13.57	\$12.71 \$14.52 \$17.14
	5-78	19 7, 28, 80, 83 62, 63, 73	Acorn Wood	10 ae	\$10.29 \$11.50 \$13.57	\$12.71 \$14.52 \$17.14
	5-62	19	Wood Pole Elbow 3" x 6"	10 ae	\$9.08	\$11.50
	5-88	19 7, 28, 80, 83 62, 63, 73	Wood Swivel Socket (Adjustable Corner)	5 ea	\$13.14 \$15.13 \$16.82	\$15.11 \$16.34 \$18.25
	5-96	19 7, 28, 80, 83 62, 63, 73	Wood Pole Socket 1 pr. Per bag	10 bags	\$9.08 \$10.18 \$13.26	\$11.50 \$13.50 \$16.57

Note: When ordering finished pole, specify color by adding color code after item no. (ex: 5-75-7)

Color Code




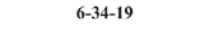
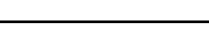
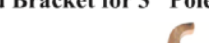



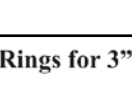







19 : Unfinished 83 : Mahogany
 7 : White 62 : Antique Gold
 28 : Walnut 63 : Gold
 80 : Oak 73 : White Gold

Cut Size Guide for 1" Pole

\$7.15 ft Unfinished
\$7.70 ft Finished
\$9.09 ft Gold Finished



3" Wood Pole And Components

Illustration	Item No	Finish	Description	Full Pack		Broken Pack
				Q'ty	Price	
3" Wood Pole  6-14-19  6-24-19  6-34-19  6-34-19  6-34-19  6-34-19	6-14-12	19 7, 28, 80, 83 62, 63, 73	Plain Pole 12'	2 pcs	\$174.24 \$203.28 \$239.88	\$203.28 \$232.32 \$274.14
	6-14-16	19 7, 28, 80, 83 62, 63, 73	Plain Pole 16'	2 pcs	\$255.55 \$298.14 \$351.81	\$298.14 \$329.12 \$388.37
	6-24-12	19 7, 28, 80, 83 62, 63, 73	Fluted Pole 12'	2 pcs	\$174.24 \$203.28 \$239.88	\$203.28 \$232.32 \$274.14
	6-24-16	19 7, 28, 80, 83 62, 63, 73	Fluted Pole 16'	2 pcs	\$255.55 \$298.14 \$351.81	\$298.14 \$329.12 \$388.37
	6-34-8	19	Twisted Wood Pole 8'	2 pcs	\$212.96	\$266.20
	6-34-12	19	Twisted Wood Pole 12'	2 pcs	\$319.44	\$399.30
Wood Bracket for 3" Pole  6-50-19  6-54-19  6-53-19  6-59-19	6-50	19 7, 28, 80, 83 62, 63, 73	Wall Bracket 3" Projection	10 ae	\$9.68 \$10.89 \$12.86	\$12.10 \$12.65 \$16.42
	6-54	19 7, 28, 80, 83 62, 63, 73	Wall Bracket 6" Projection	10 ae	\$12.71 \$15.13 \$17.85	\$14.52 \$18.15 \$21.42
	6-53	19 7, 28, 80, 83 62, 63, 73	Center Support Bracket 3" Projection	10 ae	\$10.29 \$11.50 \$13.57	\$12.71 \$14.52 \$17.14
	6-59	19 7, 28, 80, 83 62, 63, 73	Ceiling Bracket 3" Projection	10 ae	\$11.80 \$13.01 \$15.36	\$12.71 \$15.13 \$17.85
Wood Rings for 3" Pole  6-63  6-64	6-63	19 7, 28, 80, 83 62, 63, 73	Fluted Ring I.D 3-1/2" O.D 5-1/4"	20 ae	\$2.37 \$2.73 \$3.22	\$2.73 \$2.97 \$3.51
	6-64	19 7, 28, 80, 83 62, 63, 73	Plain Ring I.D 3-1/2" O.D 5-1/4"	20 ae	\$2.37 \$2.73 \$3.22	\$2.73 \$2.97 \$3.51
Wood Pole Ends & Socket for 3" Pole  6-70  6-73  6-74  6-75  6-62	6-70	19 7, 28, 80, 83 62, 63, 73	End Cap	10 ea	\$15.13 \$17.55 \$19.97	\$18.15 \$21.18 \$23.60
	6-73	19 7, 28, 80, 83 62, 63, 73	Sherwood Type	10 ea	\$21.18 \$24.20 \$28.56	\$23.60 \$27.83 \$32.85
	6-74	19 7, 28, 80, 83 62, 63, 73	Classic Type	10 ea	\$21.18 \$24.20 \$28.56	\$23.60 \$27.83 \$32.85
	6-75	19 7, 28, 80, 83 62, 63, 73	Ball Type	10 ea	\$21.18 \$24.20 \$28.56	\$23.60 \$27.83 \$32.85
	6-62	19	Wood Pole Elbow 3" x 6"	10 ea	\$19.36	\$21.78

Note: When ordering finished pole, specify color by adding color code after item no. (ex: 6-14-12-7)

Color Code	
19 : Unfinished	83 : Mahogany
7 : White	62 : Antique Gold
28 : Walnut	63 : Gold
80 : Oak	73 : White Gold

Cut Size Guide for 1" Pole
\$16.50 ft Unfinished
\$19.80 ft Finished
\$23.36 ft Gold Finished



Tieback Holder

Illustration	Item No	Description	Full Pack		Brocken Pack
			Q'ty	Price	
	20-9596	Tieback Holder	10 ea	\$10.95	\$12.05
	20-9593	Tieback Holder	10 ea	\$10.95	\$12.05
	20-9006	Tieback Holder	10 ea	\$10.95	\$12.05
	20-9001	Tieback Holder	10 ea	\$10.95	\$12.05
	20-9009	Tieback Holder	10 ea	\$10.95	\$12.05
	Q-313	Tieback Holder	10 ea	\$10.95	\$12.05
	Q-306	Tieback Holder	10 ea	\$10.95	\$12.05
	Q-302	Tieback Holder	10 ea	\$10.95	\$12.05
	JHC-9130	Tieback Holder (1 pr. Per bag)	5 ea	\$9.85	\$10.95
	JHC-9133	Tieback Holder (1 pr. Per bag)	5 ea	\$9.85	\$10.95



3/4" Iron Rod Assemble Set



NO.22-1001AX



X: Magic Finial



NO.22-1001AY



Y: Spear Finial



NO.22-1001AZ



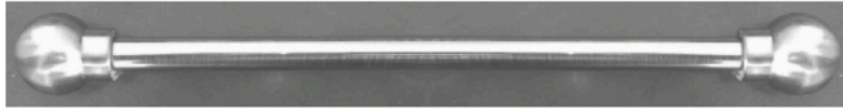
Z: Tulip Finial

Item No	Finish	Description	Full Pack		Broken Pack
			Q'ty	Price	
22-1001AX	59, 62, 65, 108	3/4" Iron Set (X: Magic Finial) 30" - 52", 2 Brackets, 2 Finials	4 set	\$19.08	\$23.88
22-1001AY	59, 62, 65, 108	3/4" Iron Set (Y: Spear Finial) 30" - 52", 2 Brackets, 2 Finials	4 set	\$19.08	\$23.88
22-1001AZ	59, 62, 65, 108	3/4" Iron Set (Z: Tulipan Finial) 30" - 52", 2 Brackets, 2 Finials	4 set	\$19.08	\$23.88
22-1002AX	59, 62, 65, 108	3/4" Iron Set (X: Magic Finial) 48" - 86", 2 Brackets, 2 Finials	4 set	\$21.00	\$27.00
22-1002AY	59, 62, 65, 108	3/4" Iron Set (Y: Spear Finial) 48" - 86", 2 Brackets, 2 Finials	4 set	\$21.00	\$27.00
22-1002AZ	59, 62, 65, 108	3/4" Iron Set (Z: Tulipan Finial) 48" - 86", 2 Brackets, 2 Finials	4 set	\$21.00	\$27.00
22-1003AX	59, 62, 65, 108	3/4" Iron Set (X: Magic Finial) 66" - 120", 2 Brackets, 2 Finials	4 set	\$27.36	\$34.20
22-1003AY	59, 62, 65, 108	3/4" Iron Set (Y: Spear Finial) 66" - 120", 2 Brackets, 2 Finials	4 set	\$27.36	\$34.20
22-1003AZ	59, 62, 65, 108	3/4" Iron Set (Z: Tulipan Finial) 66" - 120", 2 Brackets, 2 Finials	4 set	\$27.36	\$34.20

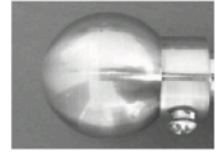
Color No: 50M Mult. Black 62 Antique Gold 65M Mult. Bronze 108 Antique Silver



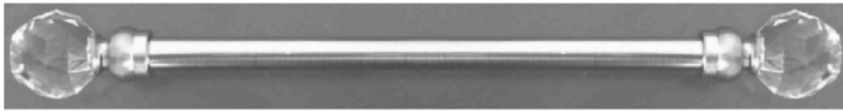
3/4" Iron Rod Assemble Set



NO.22-1002AB



B: Ball Finial



NO.22-1002AC



C: Crystal Finial

Item No	Finish	Description	Full Pack		Broken Pack
			Q'ty	Price	
22-1002AB	59, 62, 65, 108	3/4" Iron Set (X: Magic Finial) 48" - 86", 2 Brackets, 2 Finials	4 set	\$22.50	\$29.40
22-1002AC	59, 62, 65, 108	3/4" Iron Set (Y: Spear Finial) 48" - 86", 2 Brackets, 2 Finials	4 set	\$22.50	\$29.40
22-1003AB	59, 62, 65, 108	3/4" Iron Set (Z: Tulipan Finial) 66" - 120", 2 Brackets, 2 Finials	4 set	\$29.76	\$35.76
22-1003AC	59, 62, 65, 108	3/4" Iron Set (X: Magic Finial) 66" - 120", 2 Brackets, 2 Finials	4 set	\$29.76	\$35.76

Color No: 50M Mult. Black 62 Antique Gold 65M Mult. Bronze 108 Antique Silver

Tieback Holder



Item No	Finish	Description	Full Pack		Broken Pack
			Q'ty	Price	
22-2002B	22, 25, 59	Tieback Holder 2 ea per Bag	6 bag	\$9.54	\$10.74

Color No. 22 Brush Nickel 25 Satin Nickel 59M Mult. Black

Decorative Finials for 1-3/8" Pole



Ball
20-8642-62



Oak Leaf
20-8647-62



Star Fruit
20-8648-83



Diamond Faceted
20-8688-58



Princess
20-8644-62



Empire
20-8641-62



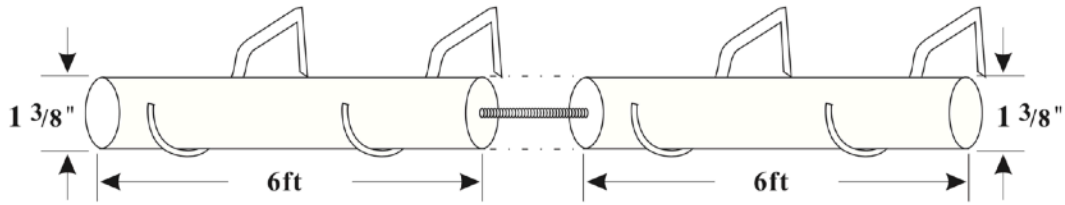
Candle
20-8645-62

Item No	Finish	Description	Full Pack		Broken Pack
			Q'ty	Price	
20-8641	59M, 62M, 65M	Empire 4-1/2" L x 3" W (1 pair / pack)	10 pk	\$11.02	\$13.60
20-8642	59M, 62M, 65M, 83	Ball 3-1/4" L x 2-1/2" W (1 pair / pack)	10 pk	\$11.02	\$13.60
20-8644	59M, 62M, 65M, 108	Princess 5" L x 3" W (1 pair / pack)	10 pk	\$11.02	\$13.60
20-8645	59M, 62M, 65M, 83	Candle 5" L x 2-1/2" W (1 pair / pack)	10 pk	\$11.02	\$13.60
20-8647	62M, 65M, 73, 83	Oak Leaf 4-1/2" L x 3" W (1 pair / pack)	10 pk	\$11.02	\$13.60
20-8648	59M, 65M, 83, 108	Star Fruit 4" L x 2-1/2" W (1 pair / pack)	10 pk	\$11.02	\$13.60
20-8688	58	Diamond Faceted 1-3/4" (1 pair / pack)	5 pk	\$34.74	\$39.46







Color No: 59M Milt. Black 62M Antique Gold, 65M Mult. Bronze, 83 Mahogany, 108 Antique Silver



1-3/8" Iron Pole Set














1-3/8 " Iron rod set-12 ft (6 ft x 2 ea)

Item No	Finish	Description	Full Pack		Broken Pack
			Q'ty	Price	
24-1001A-49		Black 1-3/8" Iron Pole Set 12 ft 6 ft x 2 ea, 4 ea Bracket No Finials	2 pk	\$47.40	\$59.40
24-1001A-62		Antique Gold 1-3/8" Iron Pole Set 12 ft 6 ft x 2 ea, 4 ea Bracket No Finials	2 pk	\$47.40	\$59.40
24-1001A-65		Bronze 1-3/8" Iron Pole Set 12 ft 6 ft x 2 ea, 4 ea Bracket No Finials	2 pk	\$47.40	\$59.40
24-1001A-108		Antique Silver 1-3/8" Iron Pole Set 12 ft 6 ft x 2 ea, 4 ea Bracket No Finials	2 pk	\$47.40	\$59.40
25-1703P	 59, 62 65, 108	2" ID Iron Ring 7 ea Pack	10 pk	\$10.74	\$12.00
24-7021	 59, 65	1-3/8" Double Bracket 1 ea Pack	5 pk	\$17.94	\$20.34

Color No. 59 Black, 62 Antique Gold, 65 Bronze, 108 Antique Silver



1" Iron Rod and Components

Illustration	Item No	Finish	Description	Full Pack		Broken Pack
				Q'ty	Price	
1" Iron Rod  23-1001	23-1001	59 C	1" x 8' / 12' / 16'	96 ft	\$3.84 \$6.24	\$5.04 \$7.44
Imperial  23-913	23-913	59 C	Imperial	10 ea	\$17.40 \$22.62	\$20.88 \$27.18
Ball  23-916	23-916	59 C	Ball	10 ea	\$15.54 \$19.02	\$21.00 \$26.70
Scroll  23-951	23-951	59 C	Scroll	10 ea	\$15.54 \$19.02	\$21.00 \$26.70
Arroyo  23-952	23-952	59 C	Arroyo	10 ea	\$15.54 \$19.02	\$21.00 \$26.70
Arrow  23-980	23-980	59 C	Arrow	10 ea	\$15.54 \$19.02	\$21.00 \$26.70
Bella  23-982	23-982	59 C	Bella	10 ea	\$15.54 \$19.02	\$21.00 \$26.70
Crown  23-984	23-984	59 C	Crown	10 ea	\$17.20 \$22.26	\$20.52 \$26.70
Classic  23-985	23-985	59 C	Classic	10 ea	\$17.20 \$22.26	\$20.52 \$26.70
Egyptian  23-986	23-986	59 C	Egyptian	10 ea	\$17.20 \$22.26	\$20.52 \$26.70
End Cap  23-730	23-730	59 C	End Cap	10 ea	\$8.34 \$10.74	\$10.74 \$13.14

Color No. 59 Black, C: Custom Color, Cut add \$1.00 per ft




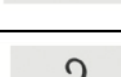
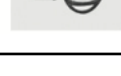



1" Iron Rod and Components

Illustration	Item No	Finish	Description	Full Pack		Broken Pack
				Q'ty	Price	
Bracket for 1" Iron Rod 	23-7001	59 C	2" Projection	10 ea	\$9.54 \$12.42	\$11.46 \$14.94
	23-7002	59 C	5" Projection	10 ea	\$10.74 \$13.98	\$12.90 \$16.74
	23-7003	59 C	5" to 8" Projection	10 ea	\$11.94 \$15.54	\$14.34 \$18.66
Traversable Bracket 	23-8001	59 C	Traversable Bracket	10 ea	\$10.74 \$13.14	\$13.14 \$15.54
Double Bracket 	23-7021	59 C	Double Bracket	10 ea	\$16.74 \$21.78	\$20.10 \$26.10
Double Traversable Bracket 	23-8021	59 C	Double Traversable Bracket	10 ea	\$22.74 \$27.54	\$26.34 \$31.14
Cutout Ring 	23-8702	59 C	1-1/2" Cutout Ring	20 ea	\$1.55 \$1.91	\$1.91 \$2.27
Ring with Clip 	25-1020	59 C	4" Ring with Clip	20 ea	\$1.02 \$1.50	\$1.26 \$1.80
Solid Ring with Eye 	25-1701	59 C	1-1/4" Ring	20 ea	\$0.95 \$1.31	\$1.19 \$1.55
	25-1702	59 C	1-1/2" Ring	20 ea	\$1.07 \$1.43	\$1.31 \$1.67
	25-1703	59 C	2" Ring	20 ea	\$1.31 \$1.67	\$1.55 \$1.91
	25-1704	59 C	2-1/2" Ring	20 ea	\$1.67 \$2.03	\$1.91 \$2.27
	25-1705	59 C	3-1/2" Ring	20 ea	\$2.27 \$2.75	\$2.82 \$3.30



3/4" Iron Rod and Components

Illustration	Item No	Finish	Description	Full Pack		Broken Pack
				Q'ty	Price	
3/4" Iron Rod  22-1001	22-1001	59 C	3/4" x 8' / 12' / 16'	96 ft	\$3.00 \$5.40	\$4.20 \$6.60
Imperial  22-913	22-913	59 C	Imperial	10 ea	\$11.88 \$15.44	\$14.22 \$18.54
Ball  22-916	22-916	59 C	Ball	10 ea	\$10.68 \$13.86	\$12.78 \$16.62
Scroll  22-918	22-918	59 C	Scroll	10 ea	\$10.68 \$13.86	\$12.78 \$16.62
Sword  22-981	22-981	59 C	Sword	10 ea	\$10.68 \$12.71	\$12.78 \$16.62
Hook  22-981	22-982	59 C	Hook	10 ea	\$10.68 \$12.71	\$12.78 \$16.62
Talon  22-983	22-983	59 C	Talon	10 ea	\$10.68 \$12.71	\$12.78 \$16.62
Crown  22-984	22-984	59 C	Crown	10 ea	\$15.54 \$20.22	\$18.66 \$23.94
Classic  22-985	22-985	59 C	Classic	10 ea	\$15.54 \$20.22	\$18.66 \$23.94
Egyptian  22-986	22-986	59 C	Egyptian	10 ea	\$15.54 \$20.22	\$18.66 \$23.94
End Cap  22-730	22-730	59 C	End Cap	10 ea	\$7.14 \$9.54	\$9.54 \$11.94

Color No. 59 Black, C: Custom Color, Cut add \$1.00 per ft



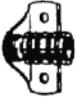





3/4" Iron Rod and Components

Illustration	Item No	Finish	Description	Full Pack		Broken Pack
				Q'ty	Price	
Bracket for 3/4" Iron Rod 	22-7001	59 C	2" Projection	10 ea	\$8.34 \$10.86	\$10.02 \$13.03
	22-7002	59 C	5" Projection	10 ea	\$9.54 \$12.42	\$11.46 \$14.94
	22-7003	59 C	5" to 8" Projection	10 ea	\$10.74 \$13.98	\$12.90 \$16.74
Double Bracket 	22-7021	59 C	Double Bracket	10 ea	\$14.34 \$18.66	\$17.22 \$22.38
Adjustable Bracke 	22-3032	59 C	Adjustable Bracket 3" to 6" 1 pr per bag	10 bag	\$6.90	\$8.28
Ring with Clip 	25-1020	59 C	4" Ring with Clip	20 ea	\$1.02 \$1.50	\$1.26 \$1.80
Solid Ring with Eye 	25-1701	59 C	1-1/4" Ring	20 ea	\$0.95 \$1.31	\$1.19 \$1.55
	25-1702	59 C	1-1/2" Ring	20 ea	\$1.07 \$1.43	\$1.31 \$1.67
	25-1703	59 C	2" Ring	20 ea	\$1.31 \$1.67	\$1.55 \$1.91
	25-1704	59 C	2-1/2" Ring	20 ea	\$1.67 \$2.03	\$1.91 \$2.27
	25-1705	59 C	3-1/2" Ring	20 ea	\$2.27 \$2.75	\$2.82 \$3.30


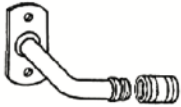


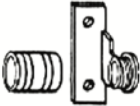




3/8" Solid Rodding and Components

Illustration	Item No	Description	Full Pack		Broken Pack
			Q'ty	Price	
 18-77	18-77-7	3/8" x 12' White	144 ft	\$1.11	\$1.39
	18-77-63	3/8" x 12' Stain Brass Finish	144 ft	\$1.11	\$1.39
 17-8429	17-8429	3/8" x 12' Stain Brass Finish	144 ft	\$1.88	\$2.58
Bracket  18-94	18-94	3/8" Bracket Brass Finish	50 pr	\$2.98	\$3.95
Vestibule Socket  18-95	18-95	3/8" Socket Brass Finish	50 pr	\$2.88	\$3.88
Spring Socket  18-209	18-209	3/8" Socket Brass Finish	10 pr	\$3.14	\$4.40
Rod Support  18-7106	18-7106	2" Support 6 per bag	25 bags	\$1.25	\$1.75









Aluminum Brass Anodized Tube and Components

Illustration	Item No	Description	Full Pack		Broken Pack
			Q'ty	Price	
 <p>21-50 21-52 21-54</p>	21-40-12	3/4" x 12'	300 ft	\$2.75	\$3.45
	21-40-16	3/4" x 16'	400 ft	\$2.75	\$3.45
	21-42-12	1" x 12'	144 ft	\$3.15	\$4.00
	21-42-16	1" x 16'	192 ft	\$3.15	\$4.00
	21-44-12	1-1/2" x 12'	144 ft	\$3.80	\$5.00
	21-44-16	1-1/2" x 16'	192 ft	\$3.80	\$5.00
 <p>18-221 thru 18-227</p>	18-221	1"	10 pr	\$3.98	\$4.88
	18-222	1-1/2"	10 pr	\$3.98	\$4.88
	18-223	2"	10 pr	\$3.98	\$4.88
	18-224	2-1/2"	10 pr	\$5.95	\$6.75
	18-225	3"	10 pr	\$6.35	\$6.95
	18-226	4"	10 pr	\$8.85	\$9.70
	18-227	5"	10 pr	\$9.95	\$10.90
 <p>21-7404 21-7407 21-7408 21-7410 21-7411</p>	21-7404	3/4" x 2" x 3"	10 pr	\$3.50	\$4.50
	21-7407	1" x 2" x 3"	10 pr	\$3.75	\$4.75
	21-7408	1" x 3" x 4"	10 pr	\$4.50	\$5.50
	21-7410	1-1/2" x 2" x 3"	10 pr	\$4.00	\$5.25
	21-7411	1-1/2" x 3" x 4"	10 pr	\$4.75	\$5.90
 <p>21-3022 thru 21-3024</p>	21-3022	3/4" Brass	10 pr	\$5.25	\$6.25
	21-3023	1" Brass	10 pr	\$7.50	\$8.75
	21-3024	1-1/2" Brass	10 pr	\$12.00	\$14.00
 <p>21-3542 21-3543</p>	21-3542	3/4" Brass	10 pr	\$8.75	\$9.75
	21-3543	1" Brass	10 pr	\$10.25	\$11.50
 <p>21-3562 21-3563</p>	21-3562	3/4" Brass	10 pr	\$4.25	\$4.95
	21-3563	1" Brass	10 pr	\$5.25	\$5.75
 <p>21-1689 thru 21-1691</p>	21-1689	3/4" Brass	1 ea	\$13.50	
	21-1690	1" Brass	1 ea	\$15.60	
	21-1691	1-1/2" Brass	1 ea	\$19.60	


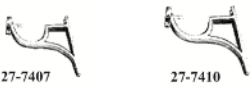









Aluminum Brass Anodized Tube and Components

Illustration	Item No	Description	Full Pack		Broken Pack
			Q'ty	Price	
End Cap (Acorn Style) solid brass  21-1912 thru 21-1914	21-1912	3/4"	10 ea	\$8.25	\$9.74
	21-1913	1"	10 ea	\$12.38	\$14.96
	21-1914	1-1/2"	10 ea	\$21.78	\$26.13
End Cap (Plastic Acorn Style)  21-1922 thru 21-1924	21-1922	3/4"	10 pr	\$3.58	\$4.95
	21-1923	1"	10 pr	\$6.33	\$8.53
	21-1924	1-1/2"	10 pr	\$10.84	\$13.75
Brass Ring solid brass  22-802 thru 22-807	22-802	1"	100 ea	\$1.82	\$2.20
	22-803	1-1/4"	100 ea	\$2.15	\$2.75
	22-804	1-1/2"	100 ea	\$2.48	\$3.30
	22-805	1-3/4"	50 ea	\$3.25	\$3.85
	22-806	2"	50 ea	\$3.85	\$4.40
	22-807	2-1/2"	50 ea	\$5.23	\$5.50
Plastic Eye Rings  22-9000 thru 22-9004	22-9000	3/4" , 100 ea per pkg	100 ea	\$0.32	\$0.39
	22-9001	1" , 100 ea per pkg	100 ea	\$0.36	\$0.43
	22-9002	1-1/4" , 100 ea per pkg	100 ea	\$0.46	\$0.55
	22-9004	1-3/4" , 100 ea per pkg	50 ea	\$0.83	\$0.94
Cafe Clips  22-1031 thru 22-1034	22-1031	3/4" , 100 ea per pkg	100 ea	\$0.19	\$0.22
	22-1032	7/8" , 100 ea per pkg	100 ea	\$0.21	\$0.26
	22-1033	1" , 100 ea per pkg	100 ea	\$0.22	\$0.28
	22-1034	1-1/4" , 100 ea per pkg	100 ea	\$0.28	\$0.33
Oval Cafe Clips  22-1037	22-1037	5/8" x 1-1/8"	100 ea	\$0.13	\$0.18



Brass Rods and Components

Illustration	Item No	Description	Full Pack		Broken Pack
			Q'ty	Price	
Brass Deco Finial  27-9098 27-6023 27-6021 27-6024 27-6022	27-9098	Americana for 1-1/2" Rod	10 ea	\$20.85	\$23.05
	27-6021	for 1" Rod	10 ea	\$14.25	\$15.95
	27-6022	for 1-1/2" Rod	10 ea	\$18.65	\$21.45
	27-6023	for 1" Rod	10 ea	\$14.25	\$15.95
	27-6024	for 1-1/2" Rod	10 ea	\$18.65	\$21.45
Brass Deco Bracket  27-7407 27-7410	27-7407	Brass Plated -Zinc Alloy for 1" Rod	10 ea	\$10.95	\$13.15
	27-7410	Brass Plated -Zinc Alloy for 1" Rod	10 ea	\$13.75	\$16.45
Brass or Chrome Long Tieback  27-1326	27-1326	Long Tieback	10 ea	\$17.55	\$21.18
Brass Tubing  27-5001 thru 27-5003	27-4001	1" x 12'	144 ft	\$15.35	\$17.55
	27-4002	1-1/2" x 12'	144 ft	\$18.65	\$19.75
	27-4003	2" x 12'	144 ft	\$25.25	\$28.51
Brass Elbow  27-5114 thru 27-5116	27-4114	1"	10 ea	\$17.55	\$19.69
	27-4115	1-1/2"	10 ea	\$20.85	\$22.99
	27-4116	2"	10 ea	\$30.25	\$32.45
Brass T- Joint Tube  27-5144 thru 27-5146	27-4144	1"	10 ea	\$23.65	\$26.95
	27-4145	1-1/2"	10 ea	\$32.45	\$35.75
	27-4146	2"	10 ea	\$48.95	\$54.45
Brass Splicer  27-5274 thru 27-5276	27-4274	1"	10 ea	\$9.90	\$12.65
	27-4275	1-1/2"	10 ea	\$14.08	\$15.18
	27-4276	2"	10 ea	\$19.75	\$25.85
Brass Bracket with Flange  27-5374 thru 27-5376	27-4374	Brass Plated -Zinc Alloy 1"	10 ea	\$15.40	\$17.60
	27-4375	Brass Plated -Zinc Alloy 1-1/2"	10 ea	\$22.00	\$26.40
	27-4376	Brass Plated -Zinc Alloy 2"	10 ea	\$21.45	\$39.60
End Cap  27-730	27-730	Brass Plated -Zinc Alloy End Cap	10 ea	\$10.95	\$13.75






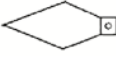









Tie Back Holder

Illustration	Item No	Finish	Description	Full Pack		Broke n Pack
				Q'ty	Price	
Tie Back Holder Extender 	27-1220	63	Brass Plated -Zinc Alloy 3-1/2" Clear.	10 ea	\$14.80	\$17.05
	27-1251	63	Brass Plated -Zinc Alloy 3-1/2" Clear.	10 ea	\$14.08	\$17.05
	27-1275	63	Brass Plated -Zinc Alloy 3-1/2" Clear.	10 ea	\$14.08	\$17.05
	27-1291	63	Brass Plated -Zinc Alloy 6" Extensor	10 ea	\$4.35	\$5.50
Tie Back Holder 	40-7603	62	Antique Gold-Zinc Alloy 4-6" / 2ea per pack	10 pk	\$16.45	\$18.65
Tieback Rosette 	27-1948	63	Brass Plated -Zinc Alloy Rosette	10 ea	\$14.25	\$17.55
Tieback 	27-4008	63	Brass Plated -Zinc Alloy	10 ea	\$10.45	\$13.75
	27-4003	63,05	Brass Plated -Zinc Alloy Chrome	10 ea	\$16.34	\$18.43
	27-1603	63	Antique Gold-Zinc Alloy	10 ea	\$10.45	\$13.75
	27-4014	63	Brass Plated -Zinc Alloy	10 ea	\$10.45	\$13.75
	27-9016L	63	Brass Plated -Zinc Alloy	10 ea	\$16.34	\$18.43
	27-9016R	63	Brass Plated -Zinc Alloy	10 ea	\$16.34	\$18.43
Deco Hook 	27-1205	63,05	Brass Plated -Zinc Alloy Chrome, Small	20 ea	\$2.75	\$3.58
	27-1206	63,05	Brass Plated -Zinc Alloy Chrome, Large	20 ea	\$3.03	\$3.85
	27-1115	63	Brass Plated -Zinc Alloy	20 ea	\$3.03	\$3.85
	27-60358	63	Brass Plated -Zinc Alloy Elephant	20 ea	\$3.03	\$3.94
	27-6014	63	Brass Plated -Zinc Alloy	20 ea	\$3.03	\$3.94
	27-1028	63	Brass Plated -Zinc Alloy	20 ea	\$4.57	\$5.45
	27-1029	63	Brass Plated -Zinc Alloy	20 ea	\$4.57	\$5.45
	27-60338	63	Brass Plated -Zinc Alloy	20 ea	\$2.12	\$2.75
	27-6015	63	Brass Plated -Zinc Alloy	20 ea	\$1.82	\$2.48

Color No. 63 Brass 05 Chrome




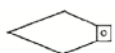












Chrome Finish Tubing and Components

Illustration	Item No	Description	Full Pack		Broken Pack
			Q'ty	Price	
Tubing  28-1001	28-1001	1" x 12'	72 ft	\$5.40	\$6.00
Adjustable Bracket  28-7407	28-7407	1" x 2" x 3"	10 pr	\$6.90	\$8.28
Finials  28-5112  28-5110	28-4112	Ball Type	10 ea	\$16.80	\$19.20
	28-4110	Spear type	10 ea	\$16.80	\$19.20
Elbow  28-5114	28-4114	1" 10" x 10"	10 ea	\$14.64	\$17.76
Flush Tee  28-5144	28-4144	1"	10 ea	\$14.79	\$17.94
Splicer - Inside  28-5274	28-4274	1"	10 ea	\$4.20	\$5.40
Bracket with Flange  28-5474	28-4474	Ceil Wall	10 ea	\$16.80	\$19.20
Connector  28-5244	28-4244	6" Both Side With Thread	10 ea	\$7.20	\$8.70
Wall Flange  28-5245	28-4245	Ceil Wall	10 ea	\$10.74	\$14.16
Socket  28-3023	28-3023	Socket	20 pr	\$9.36	\$11.04
Ring  28-1702	28-1702	1-1/2" I.D	20 ea	\$2.87	\$3.47
End Cap  28-730	28-730	End Cap	10 ea	\$13.14	\$16.20






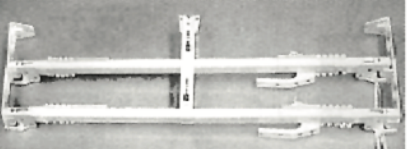
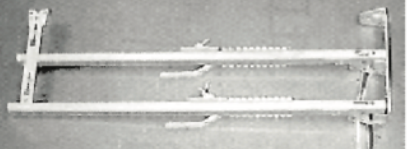
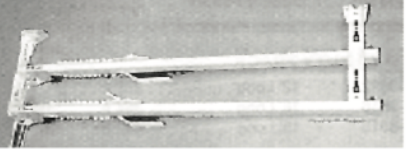
Brush Chrome Finish Tubing and Components

Illustration	Item No	Description	Full Pack		Broken Pack
			Q'ty	Price	
Tubing  29-1001	29-1001	1" x 12'	72 ft	\$5.94	\$7.14
Adjustable Bracket  29-7407	29-7407	1" x 2" x 3"	10 pr	\$7.80	\$9.48
Finials  29-5112  29-5110	29-4112	Ball Type	10 ea	\$15.54	\$17.94
	29-4110	Spear type	10 ea	\$17.94	\$20.34
Elbow  29-5114	29-4114	1" Elbow 10" x 10"	10 ea	\$16.56	\$18.96
Flush Tee  29-5144	29-4144	1" Flush Tee	10 ea	\$16.80	\$20.40
Splicer - Inside  29-5274	29-4274	1" Inside Splicer	10 ea	\$4.20	\$5.40
Bracket with Flange  29-5474	29-4474	2" Projection	10 ea	\$16.80	\$19.20
Bracket with Flange  29-5475	29-4475	5" Projection	10 ea	\$22.20	\$27.00
Connector  29-5244	29-4244	6" Both Side With Thread	10 ea	\$8.34	\$8.70
Wall Flange  29-5245	29-4245	Ceil Wall	10 ea	\$10.68	\$14.16
Socket  29-3023	29-3023	Socket	20 pr	\$9.36	\$11.04
Ring  29-1702	29-1702	1-1/2" I.D	20 ea	\$2.87	\$3.47
End Cap  29-730	29-730	End Cap	10 ea	\$13.14	\$16.20





Meteor Traverse Rod "Drop-in"

Heavy Duty Ball Bearing Adjustable Traverse Rod

Illustration	Item No	Description	Full Pack		Broken Pack
			Q'ty	Price	
 <p>10-5010 Thru 10-5019</p>	10-5010	30" - 48"	4 ea	\$16.98	\$23.50
	10-5012	48" - 86"	4 ea	\$20.98	\$26.50
	10-5014	66" - 120"	4 ea	\$22.90	\$29.50
	10-5016	86" - 150"	4 ea	\$24.40	\$32.50
	10-5018	100" - 180"	4 ea	\$28.30	\$40.00
 <p>10-5110 Thru 10-5118</p>	10-5110	30" - 48"	4 ea	\$16.98	\$23.50
	10-5112	48" - 86"	4 ea	\$20.98	\$26.50
	10-5114	66" - 120"	4 ea	\$22.90	\$29.50
	10-5116	86" - 150"	4 ea	\$24.40	\$32.50
	10-5118	100" - 180"	4 ea	\$28.30	\$40.00
 <p>10-5120 Thru 10-5128</p>	10-5120	30" - 48"	4 ea	\$16.98	\$23.50
	10-5122	48" - 86"	4 ea	\$20.98	\$26.50
	10-5124	66" - 120"	4 ea	\$22.90	\$29.50
	10-5126	86" - 150"	4 ea	\$24.40	\$32.50
	10-5128	100" - 180"	4 ea	\$28.30	\$40.00
 <p>10-5210 Thru 10-5219</p>	10-5210	30" - 48"	4 ea	\$25.50	\$31.91
	10-5212	48" - 86"	4 ea	\$39.72	\$50.19
	10-5214	66" - 120"	4 ea	\$46.89	\$58.93
	10-5216	86" - 150"	4 ea	\$49.65	\$61.61
	10-5218	100" - 180"	4 ea	\$64.47	\$81.35
 <p>10-5310 Thru 10-5318</p>	10-5310	30" - 48"	4 ea	\$25.50	\$31.91
	10-5312	48" - 86"	4 ea	\$39.72	\$50.19
	10-5314	66" - 120"	4 ea	\$46.89	\$58.93
	10-5316	86" - 150"	4 ea	\$49.65	\$61.61
	10-5318	100" - 180"	4 ea	\$64.47	\$81.35
 <p>10-5420 Thru 10-5428</p>	10-5422	30" - 48"	4 ea	\$25.50	\$31.91
	10-5422	48" - 86"	4 ea	\$39.72	\$50.19
	10-5424	66" - 120"	4 ea	\$46.89	\$58.93
	10-5426	86" - 150"	4 ea	\$49.65	\$61.61
	10-5428	100" - 180"	4 ea	\$64.47	\$81.35








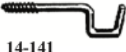

Cafe Rod

Illustration	Item No	Finish	Description	Full Pack		Broken Pack
				Q'ty	Price	
Round Sash Rod 7/16" Diameter Clearance 3/4"  14-5576	14-5576	7 63	18" - 28"	10 bags	\$2.81	\$3.93
Cafe Rod Bracket - Brass Finish  16-1238B 16-1239B	16-1238B		3/4" Bracket Clearance 1 pr per Bag	20 bags	\$1.00	\$1.45
	16-1239B		1" Bracket Clearance 1 pr per Bag	20 bags	\$2.10	\$2.95

Color No. 7 White 63 Brass



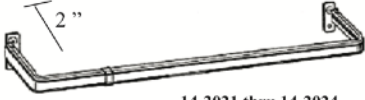
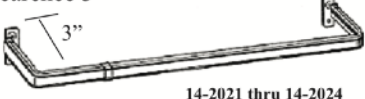

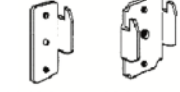
Sash Rod and Spring Tension Rod

Illustration	Item No	Finish	Description	Full Pack		Broken Pack
				Q'ty	Price	
Swivel End Sash Rod  14-108 14-109	14-108	7	11" - 19"	20 pcs	\$2.10	\$2.95
	14-109	7	20" - 36"	20 pcs	\$2.60	\$2.93
Lock Seam Sash Rod - Flat 11/16" 	14-2001	7	Flat 11/16" - 8" - 12" (6410E025)	10 pcs	\$4.57	\$6.40
	14-2002	7	Flat 11/16" - 12" - 18" (6411025)	10 pcs	\$6.47	\$9.06
	14-2003	7	Flat 11/16" - 18" - 28" (6412025)	10 pcs	\$5.68	\$7.95
	14-2004	7	Flat 11/16" - 28" - 48" (6413025)	10 pcs	\$3.46	\$4.85
	14-2005	7	Flat 11/16" - 48" - 86" 1 support included (6415025)	10 pcs	\$5.25	\$7.35
Spring Tension Rod 7/16" Round  14-3000 14-3002	14-3000	7	18" - 28"	10 ea	\$3.00	\$4.15
	14-3002	7	28" - 48"	10 ea	\$3.20	\$4.45
Adjustable Spring Tension Rod  14-3106 thru 14-3109	14-3106		16" - 24"	10	\$3.20	\$4.45
	14-3107		22" - 36"	10	\$4.20	\$5.90
	14-3108		36" - 60"	10	\$4.80	\$6.70
	14-3109		48" - 72"	5	\$5.30	\$7.40
Plastic Cord Cleat Brass Finish  27-470	27-470		3-1/4"	20 ea 100 ea	\$0.28 \$0.22	\$0.33
Curtain Rod Supports - Zinc Plated  14-141  14-152	14-414		2-1/2" (3 per bag)	20 pr	\$1.30	\$1.85
	14-152		3-1/2" (2 per bag)	20 pr	\$1.30	\$1.85

Color No. 7 White 63 Brass

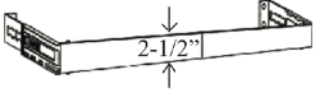





Curtain Rod

Illustration	Item No	Description	Full Pack		Broken Pack
			Q'ty	Price	
Lockseam Single Curtain Rod Clearance 2"  14-2021 thru 14-2024	14-2021	18"-28"	10 ea	\$2.60	\$3.70
	14-2022	28"-48"	10 ea	\$2.90	\$4.00
	14-2023	48"-86"	10 ea	\$4.20	\$5.90
	14-2024	66"-120"	10 ea	\$7.10	\$9.90
Lockseam Single Curtain Rod Clearance 3"  14-2021 thru 14-2024	14-2026	28"-48"	10 ea	\$3.30	\$4.60
	14-2027	48"-86"	10 ea	\$5.00	\$7.00
	14-2028	66"-120"	10 ea	\$7.40	\$10.40
Lockseam Double Curtain Rod Clearance Inside 2", Outside 3"  14-2126 thru 14-2129	14-2126	18"-28"	10 ea	\$4.60	\$6.40
	14-2127	28"-48"	10 ea	\$5.10	\$7.10
	14-2128	48"-86"	10 ea	\$7.60	\$10.70
	14-2129	66"-120"	6 ea	\$12.20	\$17.10
Curtain Rod Bracket  14-206 14-207	14-206	Single 1 pr per bag	20 bags	\$0.70	\$1.04
	14-207	Double 1 pr per bag	20 bags	\$0.70	\$1.04

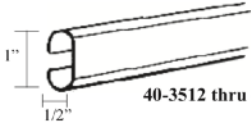


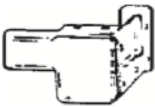




Contempo Curtain Rods

Illustration	Item No	Description	Full Pack		Broken Pack
			Q'ty	Price	
Contempo Curtain Rod 2-1/2" Wide / 3.5" - 5" Clearance Complete with Adjustable Brackets  14-6742 14-6743 14-6746 14-6747	14-6742	18" - 28"	4	\$8.20	\$11.50
	14-6743	28" - 48"	8	\$9.64	\$13.50
	14-6744	48" - 86"	4	\$13.79	\$19.30
	14-6746	66" - 120" 2 supports included	4	\$12.43	\$24.40
	14-6747	86" - 150" 3 supports included	4	\$20.29	\$28.40
Carson Holder  27-2215	27-2215	2 pcs (1 ea per bag)	10	\$2.03	\$2.42
	27-2215-1	120 ea per box	120	\$1.79	
Shower Pole  72-1171 72-1172	72-1171	42" - 72" (chrome)	10	\$9.90	\$11.55
	72-1172	42" - 72" (white)	10	\$9.90	\$11.55
Shower Rod Curtain Ring  72-294	72-294	1-3/8" (chromate) 12 units per bag	10 bag	\$1.60	\$2.23




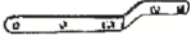







Heavy Duty Cut-to-Measure Rodding and Components

Illustration	Item No	Description	Full Pack		Broken Pack
			Q'ty	Price	
Heavy Duty Track  40-3512 thru 40-3518	40-3512	12' Long	288 ft	\$0.71 / ft	\$1.60
	40-3516	16' Long	384 ft	\$0.71/ ft	\$1.60
	Cut Add 10%				\$0.78 / ft
Heavy Duty Punched Ceiling Track  40-3612 , 40-3616	40-3612	12' Long	288 ft	1.09 / ft	\$1.45
	40-3616	16' Long	384 ft	1.09/ ft	\$1.45
Heavy Duty Sim Pully - Drop In Style  40-3568	40-3568	Ball Bearing	20 pr	\$2.75	\$3.50
Heavy Duty Pulley Sets - Push On  40-3575	40-3575	Self Lubricating	20 pr	\$2.75	\$3.50
Heavy Duty End Insert Pulley  40-3604 40-3640 / 40-3642	40-3604	Self Lubricating	20 ea	\$1.08	\$1.31
	40-3640	Self Lubricating with End Cap	20 ea	\$1.08	\$1.31
	40-3642	Ball Bearing with End Cap	20 ea	\$1.90	\$2.20
Heavy Duty Insert Pulley  40-3606	40-3606	Self Lubricating	20 ea	\$1.80	\$2.64
	40-3608	Ball Bearing	20 ea	\$1.90	\$2.94

Color No. 28 Walnut, 83 Mahogany, 62 Antique Gold









Heavy Duty Cut-to-Measure Rodding and Components

Illustration	Item No	Description	Full Pack		Broken Pack
			Q'ty	Price	
 <p>40-2612</p>	40-2612	H.D. Master Carrier	20 pr	\$3.19	\$3.55
 <p>40-2644</p>	40-2644	Overlap Arm	20 ea	\$0.95	\$1.25
 <p>40-2507</p>	40-2507	Two Way Draw Master	10 pr	\$3.19	\$3.95
 <p>40-3630</p>	40-3630	Wall Type	20 ea	\$1.29	\$1.59
 <p>40-3658</p>	40-3658	Heavy Duty Socket	10 pr	\$1.12	\$1.38
 <p>40-3660</p>	40-3660	Heavy Duty Splicer	10 ea	\$1.18	\$1.38
 <p>40-3690</p>	40-3690	Heavy Duty Ceiling Support	10 ea	\$2.59	\$3.45
<p>Stop - Locks</p>  <p>40-3694</p>  <p>40-3695</p>	40-3694	Wall	100 ea	\$0.52	\$0.68
	40-3695	Ceiling	100 ea	\$0.78	\$0.98


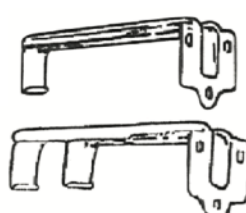


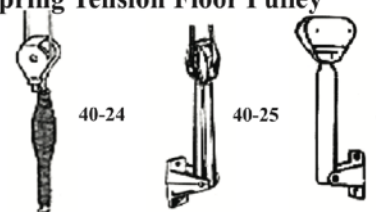


Heavy Duty Cut-to-Measure Rodding and Components

Illustration	Item No	Description	Full Pack		Broken Pack
			Q'ty	Price	
Pendant  40-812	40-812	Pendant 3 Holes 200 ea per box	1 box	\$27.55	\$0.16
Glides  40-1105  40-1106  40-1128  40-1150  40-9411	40-1105-1	Square Overhead (M600) 200 ea per box	1 box	\$20.65	\$0.16
	40-1105-2	Square Overhead (M600) 1000 ea per box	1 box	\$81.88	
	40-1106-1	Round Overhead (M608) 200 ea per box	1 box	\$20.65	\$0.18
	40-1106-2	Round Overhead (M608) 1000 ea per box	1 box	\$87.50	
	40-1128-1	Wide Shoe With Meal Pendant 200 ea per box	1 box	\$45.58	\$0.33
	40-1128-2	Wide Shoe With Meal Pendant 1000 ea per box	1 box	\$197.28	
	40-1150-1	Celcon on Train 1000 ea per box	1 box	\$27.85	\$0.05
	40-1150-2	Arrow Glide-Molded 10000 ea per box	1 box	\$239.45	
	40-9411	Snap in Glide	10 ea	\$0.40	\$0.50







Heavy Duty Cut-to-Measure Rodding and Components

Illustration	Item No	Description	Full Pack		Broken Pack
			Q'ty	Price	
SimBracket Drop in Type for Cut-to-Measure  40-3431 thru 40-3434 40-3445	40-3431	Single 1-1/2" to 2-1/2"	20 pr	\$1.95	\$2.32
	40-3432	Single 2-1/2" to 3-1/2"	20 pr	\$1.95	\$2.32
	40-3433	Single 4-1/2" to 5-1/2"	10 pr	\$2.69	\$2.98
	40-3434	Single 5-1/2" to 6-1/2"	10 pr	\$2.98	\$3.18
	40-3445	Double 5-1/2" to 6-1/2"	10 pr	\$3.25	\$3.98
Heavy Duty Support for Cut-to-Measure Rod & Meteor Rod  40-3031 thru 40-3034 40-3008	40-3031	Single 1-1/2" to 2-1/2"	10 ea	\$1.21	\$1.49
	40-3032	Single 2-1/2" to 3-1/2"	20 ea	\$1.22	\$1.50
	40-3033	Single 4-1/2" to 5-1/2"	20 ea	\$1.74	\$2.18
	40-3034	Single 5-1/2" to 6-1/2"	20 ea	\$1.74	\$2.18
	40-3008	Double 5-1/2" to 6-1/2"	20 ea	\$2.18	\$2.58
Stirrups  40-3325 40-3327	40-3325	Inside for Meteor & Jupiter Rod	30 ea 100 ea	\$0.72 \$0.65	\$0.87
	40-3327	Outside for Meteor & Jupiter Rod	30 ea 100 ea	\$0.72 \$0.65	\$0.87
Heavy Duty Metal Floor Pulley  40-20	40-20	Heavy Duty Metal Floor Pulley	20 ea 100 ea 1000 ea	\$2.04 \$1.80 \$1.59	\$2.50
Spring Tension Floor Pulley  40-24 40-25 40-71	40-24	Spring Tension Floor Pulley	20 ea 100 ea 1000 ea	\$0.95 \$0.82 \$0.66	\$1.20
	40-25	Plastic Body Floor Pulley	20 ea 100 ea	\$0.86 \$0.69	\$0.97
	40-71	Double Uni Bearing	10 ea	\$6.30	\$8.28



Heavy Duty Cut-to-Measure Rodding and Components

Illustration	Item No	Description	Full Pack		Broken Pack
			Q'ty	Price	
Regular Bracket / Single-Drop In  40-2431 thru 40-2434	40-2431	1-1/2" to 2-1/2"	20 pr	\$2.08	\$2.88
	40-2432	2-1/2" to 3-1/2"	20 pr	\$2.36	\$3.25
	40-2433	3-1/2" to 4-1/2"	20 pr	\$2.51	\$3.64
	40-2434	5" to 6"	20 pr	\$2.88	\$3.74
Regular Bracket-Drop In  40-2444 40-2445	40-2444	3-1/2" to 4-1/2"	20 pr	\$3.39	\$3.82
	40-2445	4-1/2" to 6"	20 pr	\$3.52	\$4.08
Support for Regular Duty Track /  40-2251 thru 40-2253	40-2251	1-1/2" to 2-1/2"	10 ea	\$1.46	\$2.65
	40-2252	2-1/2" to 3-1/2"	20 ea	\$1.57	\$2.20
	40-2253	3-1/2" to 4-1/2"	20 ea	\$1.68	\$2.35
Support for Double  40-2107 40-2108	40-2107	4" x 5"	20 ea	\$2.38	\$2.88
	40-2108	5" x 6"	20 ea	\$2.50	\$2.98



Oval Rod Components Cut-to-Measure

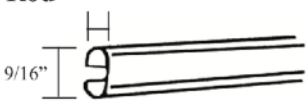
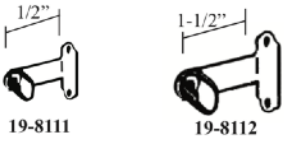






Illustration	Item No	Description	Full Pack		Broken Pack
			Q'ty	Price	
Oval Rod $11/32''$  19-9001	19-9001	12' Length , White	504	\$0.46	\$0.64
	Cut Add 10%				\$0.50
Oval Rod Brackets  19-8111 19-8112	19-8111	1/2" Proj. Clearence	25	\$1.48	\$2.06
	19-8112	1-1/2" Proj.Clearence	20	\$1.67	\$2.34
Push on Bracket for use with ReversibleElbow  19-8115	19-8115	Zinc Finish	20	\$1.25	\$1.75
Single Elbow Bracket  19-8118	19-8118	Zinc Finish	20 bag	\$0.70	\$1.04
Double Elbow Bracket  19-8128	19-8128	Zinc Finish	20 bag	\$0.70	\$1.04
Reversible Elbow  19-8171 thru 19-8176	19-8171	1-1/2" to 2-1/2"	10	\$1.58	\$2.20
	19-8172	2-1/2" to 3-1/2"	10	\$1.97	\$2.44
	19-8173	3-1/2" to 4-1/2"	10	\$2.09	\$2.91
	19-8175	5-1/2" to 6-1/2"	10	\$3.82	\$5.35
	19-8176	7-1/2" to 9-1/2"	10	\$4.89	\$6.85
Oval Rod Outside Splicer  19-8180	19-8180	Oval Rod Outside Splicer	20	\$0.68	\$0.91
Oval Rod Spring Socket  19-8182	19-8182	Oval Rod Spring Socket	10 prs	\$2.95	\$4.60

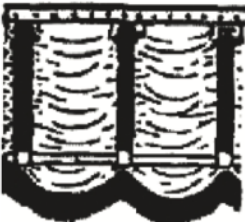






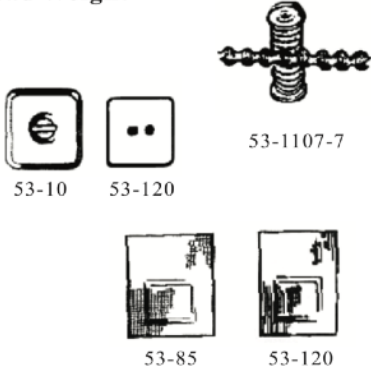




Illustration	Item No	Description	Full Pack		Broken Pack
			Q'ty	Price	
Roman & Austrian Shad Cord  837-49 837-50 837-51 837-52 837-53	37-49	0.9 mm	1000 yds/roll	\$83.49	
	37-50	1.4 mm	1000 yds/roll	\$95.59	
	37-53	1.6 mm	1000 yds/roll	\$100.43	
	37-51	1.8 mm	1000 yds/roll	\$100.43	
	37-52-1	Size #2.5	100 yds/roll	\$15.68	
	37-52-2	Size #2.5	500 yds/roll	\$66.22	
	37-53-3	Size #2.5	1000 yds/roll	\$117.98	
Cotton Diamond Braid Fiberglass Cord  837-1240	37-1240-1	Size # 4	100 yds/spool	\$17.55	
	37-1240-2	Size # 4	500 yds/spool	\$71.06	
	37-1240-3	Size # 4	1000 yds/spool	\$130.46	
Cotton Diamond Braid Special Cord  837-1243	37-1243	Size 3-3/4"	2000 yds/spool	\$187.55	
Replacement Cord  837-2055B	37-2055B	48 ft per bag	10 bags	\$3.91	\$4.79
Polyester Fiberglass Cord  837-5440	37-5440-1	Size # 4	100 yds/spool	\$17.55	
	37-5440-2	Size # 4	500 yds/spool	\$71.06	
	37-5440-3	Size # 4	1000 yds/spool	\$130.46	
Cotton Diamond Braid 1/16" Wire Centre Cord  837-8032	37-8032	Size 3-3/4"	100 yds/spool	\$108.39	

Illustration	Item No	Description	Full Pack		Broken Pack
			Q'ty	Price	
Buckram Non-Woven One side Adhesive Washable Hovotex HS 100 yds per roll  54-3130	54-3130-3	3" (25 roll / box)	25 roll	\$18.65	\$20.85
	54-3130-4	4" (25 roll / box)	25 roll	\$19.64	\$21.45
	54-3130-5	5" (25 roll / box)	25 roll	\$24.04	\$27.45
	54-3130-6	6" (25 roll / box)	25 roll	\$28.38	\$32.12
Lead Weight 	53-10	1" x 1" Uncovered 1000ea per box	1 box	\$89.00	\$0.25
	53-85	1" x 1" covered 1000 ea per box	1 box	\$119.00	\$0.35
	53-120	3/4" x 3/4", Uncovered	1 box	\$72.00	\$0.18
	53-80	3/4" x 3/4", Vinyl Covered	1 box	\$89.00	\$0.20
	53-1107-7	White Weight Braid (Short Tape) 200 yds per roll	1 roll	\$95.00	\$0.75
Utility Pins Dress Maker Medium Weight  56-7002 56-7003	56-7002	#20, 1-1/4", 1 lb per box	5 box	\$13.15	\$15.02
	56-7003	#24, 1-1/2", 1 lb per box	5 box	\$13.15	\$15.02
T-Pins Nickel Plated Steel Sturdy with Sharp Points  56-7031 thru 56-7034	56-7031	#20, 1-1/4", 1/2 lb per box	10 box	\$14.80	\$15.57
	56-7032	#24, 1-1/2", 1/2 lb per box	10 box	\$11.68	\$12.98
	56-7033	#28, 1-3/4", 1/2 lb per box	10 box	\$11.68	\$12.98
	56-7034	#32, 2", 1/2 lb per box	10 box	\$11.68	\$12.98
Large White Plastic Head Steel Florist Pins  56-7062	56-7062	2" Florist Pin	10 box	\$9.57	\$10.89
Push Pin  56-7050	56-7050	5/8" A luminum Head (bulk) 100 ea per box	10 box	\$10.59	\$13.15



Drapery Pin Hooks



















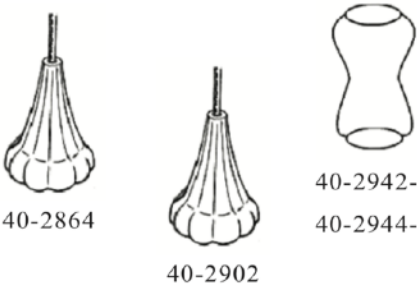

Illustration	Item No	Description	Full Pack		Broken Pack
			Q'ty	Price	
Heavy Duty Hooks Do not use Flame Proofed Fabrics 	56-1460	5M per box for hand pin	1 M 5 M 10 M	\$25.25 \$24.20 \$22.83	
Heavy Duty Pin on a Stick 	56-1460S	Pin on stick	1 ea	\$3.50	
Stainless Steel Hooks Usable with Flame Proofed Fabrics 	56-1490	Stainless Steel 1-5/6", 1-1/4" 1 M per box	1 M 10 M 30 M	\$106.81 \$101.86 \$96.69	
DK- Red Head Pinner 	56-1450	For 56-1475 & 56-1460 Heavy Duty/ Stainless Pin Hook	1 ea	\$24.20	
Jet Pinner 	56-1425	For 56-1460 & 56-1460X Pin Hook	1 ea	\$39.00	
Standard Pin Hooks Do not use Flame Proofed Fabrics  56-376	56-376-1	1", 200 ea per box	1 box	\$5.72	
	56-376-2	1", Offset 1000 ea per box	1 box	\$19.25	
	56-376B	1", 14 ea per box	50 bags	\$0.70	\$0.83
Heavy Duty No Tilt Pin Hooks Do not use Flame Proofed Fabrics  56-1402	56-1402-1	2-1/4", Bulk, Barrel	200 box	\$8.40	
	56-376-2	2-1/4", Bulk, Barrel	1M box	\$26.40	
	56-376B	2-1/4", 14 ea per box	50 bags	\$0.70	\$0.83
Master Lock Wall Pleater Hooks  56-188B	56-188B	10 ea per bag	10 bags	\$3.03	\$3.63
Heavy Duty Pin Hooks  56-1599B	56-1599B	14 ea per bag	20 bags	\$0.77	\$1.19
Tie Back Hooks  56-2118	56-2118-1	200 ea per bag	1 box	\$14.08	\$0.22
	56-2118-2	1000 ea per bag	1 box	\$64.11	
Sew on Hooks  56-2515	56-2515	Zinc Finish	200 ea	\$0.12	\$0.15
Stage Drapery Hooks Heavy Duty  56-2517	56-2517	Chromate Finish	200 ea	\$0.12	\$15.00
Pin on French Heading Hooks  56-2687B	56-2687B	3" Hook, 14 ea per bag	10 bags	\$2.40	\$3.03

Illustration	Item No	Description	Full Pack		Broken Pack
			Q'ty	Price	
Thread Clip  52-TCI	52-TCI	Nickel Plated	1 pr	\$16.03	
Shears  52-28 52-29 52-20 52-22	52-28	8" Wiss	1 pr	\$37.95	
	52-29	9" Industrial Wiss	1 pr	\$47.08	
	52-20	10" Wiss	1 pr	\$50.27	
	52-22	12" Wiss	1 pr	\$53.79	
Shear  52-765	52-765	6" EmbroideryWiss	1 pr	\$25.14	
Table Covering Canvas  52-839	52-839	72" Width	1 yd	\$15.95	
Tailors Fluorescent Crayon  52-9510	52-9510	32 ea per box Sold by Box Only	1 box	\$15.62	
Tassels  40-2864 40-2902 40-2942-7 40-2944-7	40-2864	Plastic Tassel, Less Weight Tulip Type, Bulk	40 prs	\$0.54	\$0.72
	40-2902	With Weight White 1 pr per bag	40 prs	\$2.77	\$3.23
	40-2942-7	Wood Tassel White, Small	50 ea	\$0.54	\$0.76
	40-2944-7	Wood Tassel White, Large	50 ea	\$0.75	\$0.99
Replaceable Table Ruler - Self Adhesive  9949	90-9949	20 ft Table Ruler	1 ea	\$28.55	



Shade Pulley and Cord Lock and Roman Shade Rib

Illustration	Item No	Description	Full Pack		Broken Pack
			Q'ty	Price	
Metal Type Austrian Shade Pulley 	57-1004	PVC Wheel	50 ea	\$0.94	\$1.10
	57-1006	Solid Wheel	50 ea	\$0.94	\$1.10
	57-1008	Ball Bearing	50 ea	\$1.16	\$1.38
Austrian Shade Cord Lock 	57-1010	3 Cord	20 ea	\$1.32	\$1.65
	57-1012	5 Cord	20 ea	\$1.43	\$1.82
Austrian Shade Pulley 	57-1523	3 Cord	50 ea	\$0.83	\$1.05
	57-1524	5 Cord	50 ea	\$0.94	\$1.10
Roman Shade Rib 1/4 Fiberglass 	57-1208-06	6 ft	50 pcs	\$2.02	\$2.42
	57-1208-08	8 ft	50 pcs	\$2.68	\$3.37
	57-1208-12	12 ft	50 pcs	\$3.97	\$4.36
	57-1208-16	16 ft	50 pcs	\$5.38	\$6.59
Line Cleats 	27-463	3-1/2" Clearance Brass and Chrome	10 ea	\$2.29	\$2.73
	27-464	2-1/2" Clearance Brass and Chrome	20 ea	\$1.82	\$2.42
	27-470	Plastic Cord Cleat 3-1/4" Clearance(Clear)	20 ea	\$0.50	\$0.61
	27-475	Plastic Cord Cleat 3-1/4" Clearance(Gold)	100 ea 20 ea	\$0.28 \$0.32	\$0.43
Brass Cord Cleats 	27-550	Brass Cord Cleats	10 ea	\$2.53	\$3.25
Brass Cord Weight 	27-1400	Brass Cord Weight	20 ea	\$2.75	\$3.25
	27-60153	Brass Cord Weight	20 ea	\$2.75	\$3.25
	27-60161	Brass Cord Tassel	10 ea	\$4.35	\$5.50



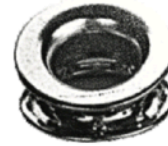
Metal-All Grommets - Made in Brass



56-4010



64 Ant. Brass



12 Nickel



63 Brass






59 Black



11 Matte Nickel

Item No	Finish	Description	Full Pack		Broken Pack
			Q'ty	Price	
56-4002	#12 #63	#2 Grommet ID 3/8"	100 ea	\$0.09	\$0.11
56-4010	#11 #12 #59 #63 #64	#10 Grommet ID 1-1/2"	100 ea	\$2.08	\$2.48

Illustration	Item No	Description	Full Pack	
			Q'ty	Price
Cutter  56-4502/56-4510	56-5402	#2 Cutter	1 ea	\$55.00
	56-4510	#10 Cutter	1 ea	\$82.50
Setter  56-4602/56-4610	56-4602	#2 Setter	1 ea	\$55.00
	56-4610	#10 Setter	1 ea	\$82.50
Hand Adaptor  56-4800	56-4800	Hand Adaptor	1 ea	\$55.00



Plastic -All Grommets -Made in Plastic



62 Ant. Gold



11 Matte Nickel



7 White



59 Black



63 Gold



#12 Nickel

Item No	Finish	Description	Full Pack		Broken Pack
			Q'ty	Price	
56-4210	#7 #11 #12 #59 #62 #63	#10 Grommet ID 1-1/2"	100 ea	\$0.65	\$0.83
56-4214	#7 #11 #12 #59 #62 #63	#14 Grommet ID 1-1/2"	100 ea	\$1.42	\$1.65



59 Black



#65 Ant Bronze



11 Matte Nickel



62 Ant. Gold



7 White

Illustration	Item No	Finish	Description	Full Pack		Broken Pack
				Q'ty	Price	
Tape With Rings  56-8010	56-8010	#65 #11 #62 # 7	3-3/4" Tape With Metal Rings 50 yds (roll)	50 yds	\$4.35	\$5.50
Ring  56-4209	56-4209	#59 #65 #11 #62 #7	#10 Grommet ID 1-1/2"	100 ea	\$0.54	\$0.72


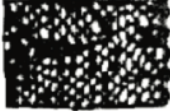

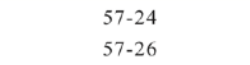

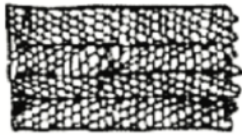

Illustration	Item No	Description	Full Pack	
			Q'ty	Price
Flat Tape (Light Weight)  57-22  57-28  57-24  57-26	57-22-7	1/4" White, 720 yds per roll	720 yds	\$0.08
	57-22-2	1/4" Natural, 720 yds per roll	720 yds	\$0.08
	57-24	1/2" White, 720 yds per roll	720 yds	\$0.19
	57-26	3/4" White, 720 yds per roll	720 yds	\$0.22
	57-28	1" White, 720 yds per roll	720 yds	\$0.26
Flat Tape (Medium Weight)  57-14 57-16 57-18	57-14-2	1/2" Natural, 360 yds per roll	360 yds	\$0.23
	57-14-7	1/2" White, 360 yds per roll	360 yds	\$0.23
	57-16-2	3/4" Natural, 360 yds per roll	360 yds	\$0.28
	57-16-7	3/4" White, 360 yds per roll	360 yds	\$0.28
	57-18-2	1" Natural, 360 yds per roll	360 yds	\$0.32
	57-18-7	1" White, 360 yds per roll	360 yds	\$0.32
Flat Tape (Heavy Weight)  57-32	57-32-2	1" Natural	100 yds	\$0.43
	57-32-7	1" White	100 yds	\$0.43
Clear Tape  57-88	57-88-58	1" Clear	144 yds	\$0.43





Illustration	Item No	Description	Full Pack	
			Q'ty	Price
<p>Hook and Loop Tape Sew on Tape</p>  <p>57-40 thru 57-45</p>	57-40	5/8" Hook	50 yds	\$0.65
	57-41	5/8" L oop	50 yds	\$0.65
	57-42	3/4" Hook	50 yds	\$0.76
	57-43	3/4" L oop	50 yds	\$0.76
	57-44	1" Hook	50 yds	\$0.98
	57-45	1" L oop	50 yds	\$0.98
<p>Pressure Sensitive Backing</p>  <p>57-52 thru 57-55</p>	57-52	3/4" Hook	25 yds	\$1.53
	57-53	3/4" L oop	25 yds	\$1.53
	57-54	1" Hook	25 yds	\$1.86
	57-55	1" L oop	25 yds	\$1.86



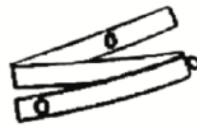







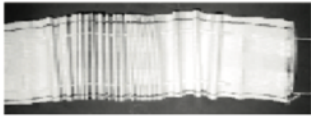

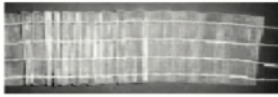
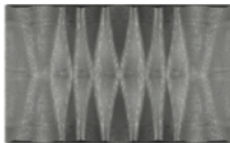








Illustration	Item No	Description	Full Pack	
			Q'ty	Price
Austrian Shade Tape 2 Cord with Ring  57-75  57-78	57-75-7	White, with Loop	72 yds	\$0.72
	57-78-7	White, with Ring	72 yds	\$1.43
	57-78-2	Natural, with Ring	72 yds	\$1.50
Roman Shade Tape with Ring  57-81	57-81-7	White	72 yds	\$1.09
	57-81-2	Natural	72 yds	\$1.09
Translucent Roman Shade Tape with Ring  57-81	57-81-58	Translucent Roman Shade Tape with Ring	72 yds	\$1.43
Single Shirr Tape  57-170	57-170-7	5/8" White	144 yds	\$0.32
	57-170-2	5/8" Natural	144 yds	\$0.32
3" Smoked Pleats  57-173	57-173-7	Smoked Pleat with 4 Cord White, 55 yds per roll	1 roll	\$60.50
2" Shirr Rite/Pencil Pleats  57-175	57-175-7	White, 2" 72 yds per roll	1 roll	\$54.65
	57-175-2	Natural, 2" 72 yds per roll	1 roll	\$54.65
1-1/2" Double Shirr Tape  57-176	57-176-7	1-1/2" White, 144 yds per roll	144 yds	\$0.54
	57-176-2	1-1/2" Natural, 144 yds per roll	144 yds	\$0.54

Illustration	Item No	Description	Full Pack		Broken Pack
			Q'ty	Price	
2" Pencil Pleats  57-179	57-179-7	2" , Pencil Pleats with 2 cord, 55 yds per roll	5 rolls	\$27.83	\$33.40
Best Pleat Tape 3-1/2"  57-62	57-62	3-1/2" B est Pleat 100 yds per roll	100 yds	\$1.07	\$1.51
4" Pencil Pleats  57-180	57-180-7	White, 4" 55 yds per roll	5 rolls	\$57.48	\$68.97
	57-180-2	Natural, 4" 55 yds per roll	5 rolls	\$57.48	\$68.97
4" Broken Pencil Pleats  57-181	57-181-7	White, 4" 55 yds per roll	5 rolls	\$58.03	\$68.97
	57-181-2	Natural, 4" 55 yds per roll	5 rolls	\$58.03	\$68.97
4" Translucent Pencil Pleats  57-181-58	57-181-58	4" T ranslucent Pencil Pleats with 4 cord, 55 yds per roll	5 rolls	\$63.53	\$76.23
4" D iamond Pleats  57-188	57-188-7	White, 4" 55 yds per roll	5 rolls	\$63.34	\$76.45
	57-188-2	Natural, 4" 55 yds per roll	5 rolls	\$65.34	\$76.45
1" T ranslucent Flat Tape  57-190-58	57-190-58	1" T ranslucent Flat Tape 55 yds per roll	5 rolls	\$23.60	\$28.31



Tapes and Cotton Flex Cord

Illustration	Item No	Description	Full Pack		Broken Pack
			Q'ty	Price	
4 Cord Shirr Tape 	57-10528-7	3-3/4" White, 36 yds per roll	5 rolls	\$29.15	\$34.98
	57-10528-2	3-3/4" Natural 36 yds per roll	5 rolls	\$29.15	\$34.98
Interlock Tape 	57-210	72 yds per roll	5 rolls	\$27.72	\$30.80
Cotton Flex Cord 	57-405-2	5/32" 500 yds per roll	500 yds	\$0.10	
	57-405-3	6/32" 500 yds per roll	500 yds	\$0.13	
	57-405-4	8/32" 500 yds per roll	500 yds	\$0.17	
	57-405-7	1/2" 275 yds per roll	275 yds	\$48.00	
	57-405-9	1" 80 yds per roll	80 yds	\$0.99	
	57-405-10	1-1/4" 84 yds per roll	84 yds	\$1.08	
Double Shirr Tape 	57-172-7	1" White	144 yds	\$0.36	
	57-172-2	1" Natural	144 yds	\$0.36	
Double Shirr Rite Tape 	57-174-7	1" White	144 yds	\$43.00	
	57-174-2	1" Natural	144 yds	\$43.00	
Special Ring - Extra Strong 	22-1426	3/8" 1000 ea per pk	3 pks	\$17.05	
Brass Ring (Die Cast) For Austrian Roman Shade 	22-181-63	Brass 3/8" 1000 ea per pk	1 pk	\$33.50	
	22-181-7	White 3/8" 1000 ea per pk	1 pk	\$33.50	
Brass Ring - Die Cast 	22-1581	5/8" 200 ea per pk	200 ea	\$0.28	\$0.39
	22-1582	3/4" 200 ea per pk	200 ea	\$0.33	\$0.44
	22-1583	1" 200 ea per pk	200 ea	\$0.50	\$0.72
	22-1584	1-1/2" 200 ea per pk	200 ea	\$0.61	\$0.83

Illustration	Item No	Description	Full Pack		Broken Pack
			Q'ty	Price	
Decorators Glue  35-8417  35-8416	35-8416	Used for Trims Fabric & Fringes 1 qt	6 qts	\$17.58	\$20.88
	35-8417	Used for Trims Fabric & Fringes 1 gal	4 gals	\$65.78	\$75.68
DK Silicone  70-100 70-888	70-100	Heavy Duty	12 cans	\$7.15	\$8.25
	70-888	Dry Silicone for Drapery Hardware	12 cans	\$7.15	\$8.25
Spring Crest Drapery Dressing  70-998  70-999  70-1000	70-998	Trigger Sprayer	1 ea	\$2.15	
	70-999	32 oz	12 ea	\$5.23	\$6.49
	70-1000	1 gal	4 gals	\$12.65	\$16.23
Cleaning Fluid  70-9753	70-9753	Everblum Cleaning Fluid Premium 1 gal / can	6 gals	\$71.28	\$80.96



Staple and Gun




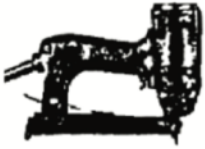

Illustration	Item No	Description	Full Pack		Broken Pack
			Q'ty	Price	
Staple Gun  58-P22	58-P22	Arrow Plier Type Staple Gun	1 ea	\$21.95	
Staple for 58-P22 Arrow Plier Type  58-22S	58-22S-1	1/4", 5000 ea per box	5 boxes	\$3.85	\$4.68
	58-22S-2	5/16", 5000 ea per box	5 boxes	\$4.13	\$5.23
Duofast Staples  58-5412 58-3412	58-5412	3/8", 5000 ea per box	5 boxes	\$13.18	\$15.38
	58-3412	3/8", 5000 ea per box (for Rocama Tacker)	5 boxes	\$13.18	\$15.98
Electric Staple Gun  58-7000  58-5412	58-7000	Duo Fast	1 ea	\$269.50	
	58-5412	3/8" S tiple for Electric Gun	5 boxes	\$12.08	\$14.16

Illustration	Item No	Description	Full Pack	
			Q'ty	Price
3/8" Rod Cutter  40-1161	40-1161	Heavy Duty Rod Cutter for 3/8" Steel Rodding	1 ea	\$275.00
Lacing Hook  40-4026	40-4026	Hook	1 ea	\$1.09
Track Knee Bender  40-4001	40-4001	Heavy Duty Track	1 ea	\$65.45
Track Cutter  40-4050	40-4050	DK Brand Special 3 Size Cutter Heavy Duty Track & Oval Rod	1 ea	\$217.80
Track Punch  40-4055	40-4055	Track Punch Stand Heavy Duty Track	1 ea	\$275.00
Track Spreader  40-4060	40-4060	Used to Spread Track so that carrier or glides can be inserted or removed	1 ea	\$15.40




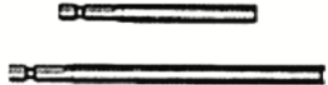
Illustration	Item No	Description	Full Pack	
			Q'ty	Price
Awls  59-7A	59-7A	Awls 6-1/2"	1 ea	\$10.45
Taper Hex Magnetic Socket  59-205	59-205	Magnetic Socket for 63-250EX-6	1 ea	\$6.22
Hex Head Attachment - Power  63-250EX	63-250EX-4	4"	1 ea	\$6.62
	63-250EX-6	6"	1 ea	\$7.39
	63-250EX-8	8"	1 ea	\$8.60
Magnetic Bit Holder Hex Drive Special for Drapes/Blind Installer  59-3004 59-3006 59-3008 59-3010	59-3004	4"	1 ea	\$10.84
	59-3006	6"	1 ea	\$11.94
	59-3008	8"	1 ea	\$14.85
	59-3010	10"	1 ea	\$18.10

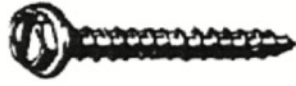


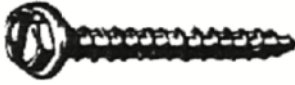


Illustration	Item No	Description	Full Pack		Broken Pack
			Q'ty	Price	
Hex Washer Head Screws Brite Brass Plated - Slotted  61-5701 61-5703 61-5705	61-5701-1	6 x 3/4"	200 ea	\$8.17	\$0.07
	61-5701-2	6 x 3/4"	1000 ea	\$28.66	
	61-5703-1	6 x 1-1/4"	200 ea	\$11.18	\$0.08
	61-5703-2	6 x 1-1/4"	1000 ea	\$38.79	
	61-5705-1	6 x 1-1/2"	200 ea	\$11.88	\$0.08
	61-5705-2	6 x 1-1/2"	1000 ea	\$41.90	
Hex Head Self Tapping Washer Tex Sheet Metal Screws with Drill Point  61-5711 61-5713 61-5715 61-5717	61-5711-1	6 x 1/2"	200 ea	\$19.50	\$0.11
	61-5711-2	6 x 1/2"	1000 ea	\$72.68	
	61-5713-1	6 x 5/8"	200 ea	\$20.91	\$0.11
	61-5713-2	6 x 5/8"	1000 ea	\$73.72	
	61-5715-1	8 x 5/8"	200 ea	\$21.67	\$0.13
	61-5715-2	8 x 5/8"	1000 ea	\$75.75	
	61-5717-1	8 x 3/4"	200 ea	\$23.07	\$0.14
	61-5717-2	8 x 3/4"	1000 ea	\$77.99	
Hex Washer Head Screws Brite Zinc Plated - Slotted  61-5721 61-5722 61-5723 61-5724 61-5725 61-5726	61-5721-1	6 x 1/2"	200 ea	\$6.29	\$0.07
	61-5721-2	6 x 1/2"	1000 ea	\$19.57	
	61-5722-1	6 x 5/8"	200 ea	\$6.85	\$0.07
	61-5722-2	6 x 5/8"	1000 ea	\$20.91	
	61-5723-1	6 x 3/4"	200 ea	\$7.83	\$0.07
	61-5723-2	6 x 3/4"	1000 ea	\$23.41	
	61-5724-1	6 x 1"	200 ea	\$8.88	\$0.08
	61-5724-2	6 x 1"	1000 ea	\$28.59	
	61-5725-1	6 x 1-1/4"	200 ea	\$10.14	\$0.08
	61-5725-2	6 x 1-1/4"	1000 ea	\$33.48	
	61-5726-1	6 x 1-1/2"	200 ea	\$11.18	\$0.09
	61-5726-2	6 x 1-1/2"	1000 ea	\$34.24	

Illustration	Item No	Description	Full Pack		Broken Pack
			Q'ty	Price	
 <p>61-5731 thru 61-5737</p>	61-5731-1	8 x 5/8"	200 ea	\$6.55	\$0.07
	61-5731-2	8 x 5/8"	1000 ea	\$20.49	
	61-5732-1	8 x 3/4"	200 ea	\$7.85	\$0.07
	61-5732-2	8 x 3/4"	1000 ea	\$25.23	
	61-5733-1	8 x 1"	200 ea	\$9.32	\$0.08
	61-5733-2	8 x 1"	1000 ea	\$29.95	
	61-5734-1	8 x 1-1/4"	200 ea	\$10.12	\$0.08
	61-5734-2	8 x 1-1/4"	1000 ea	\$32.62	
	61-5735-1	8 x 1-1/2"	200 ea	\$11.32	\$0.08
	61-5736-1	8 x 1-1/2"	1000 ea	\$38.27	
	61-5735-2	8 x 2"	200 ea	\$17.25	\$0.11
	61-5736-2	8 x 2"	1000 ea	\$53.12	
	61-5737-1	8 x 2-1/2"	200 ea	\$20.77	\$0.12
	61-5737-2	8 x 2-1/2"	1000 ea	\$63.44	
Flat Head Phillips Screws Brite Zinc Plated  <p>61-5751 61-5753 61-5755</p>	61-5751-1	6 x 3/4"	200 ea	\$7.00	\$0.04
	61-5751-2	6 x 3/4"	1000 ea	\$22.97	
	61-5753-1	6 x 1"	200 ea	\$7.99	\$0.07
	61-5753-2	6 x 1"	1000 ea	\$28.29	
	61-5755-1	6 x 1-1/2"	200 ea	\$8.17	\$0.08
	61-5755-2	6 x 1-1/2"	1000 ea	\$35.61	
Flat Head Phillips Sheet Metal Screws  <p>61-5761 61-5763 61-5765 61-5767</p>	61-5761-1	8 x 1"	200 ea	\$9.99	\$0.08
	61-5761-2	8 x 1"	1000 ea	\$36.28	
	61-5763-1	8 x 1-1/4"	200 ea	\$11.98	\$0.09
	61-5763-2	8 x 1-1/4"	1000 ea	\$41.21	
	61-5765-1	8 x 2"	200 ea	\$15.64	\$0.10
	61-5765-2	8 x 2"	1000 ea	\$50.58	
	61-5767-1	8 x 2-1/2"	200 ea	\$22.97	\$0.12
	61-5767-2	8 x 2-1/2"	1000 ea	\$85.18	



Molly Anchors and Bolt


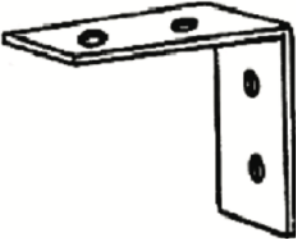

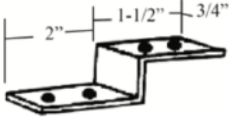





Illustration	Item No	Description	Full Pack		Broken Pack
			Q'ty	Price	
 61-8100	61-8100	Channel Protector	1 ea	\$0.44	
 61-8011 61-8013 61-8015	61-8011	6 x 8 x 3/4" 100 ea per box	1 box	\$18.62	\$0.48
	61-8013	6 x 8 x 1" 100 ea per box	1 box	\$19.14	\$0.48
	61-8015	6 x 8 x 1-1/2" 100 ea per box	1 box	\$20.39	\$0.48
 61-10	61-10	Size 6 to 8 Screws Approx. 1000 ea per box	1 box	\$23.84	
	61-10B	12 per bag	20 bags	\$0.67	
 61-9013 61-9026	61-9013	8 x 1" , 100 ea per box	1 box	\$28.08	\$0.39
	61-9026	10 x 1" , 100 ea per box	1 box	\$28.75	\$0.40
 62-440 62-441	62-440	Short / 100 ea per box	1 box	\$35.94	\$0.52
	62-441	Long / 100 ea per box	1 box	\$40.27	\$0.53
 62-452 62-453	62-452	Short / 100 ea per box	1 box	\$40.25	\$0.43
	62-453	Long / 100 ea per box	1 box	\$46.00	\$0.51
 62-454 62-455	62-454	Short / 100 ea per box	1 box	\$25.87	\$0.29
	62-455	Long / 100 ea per box	1 box	\$33.06	\$0.37
 62-1001 62-1002	62-1001	1/8" x 2 " / 50 ea per box	1 box	\$0.50	\$0.65
	62-1002	1/8" x 3 " / 50 ea per box	1 box	\$0.60	\$0.70

Illustration	Item No	Description	Full Pack		Broken Pack
			Q'ty	Price	
Corner Irons Brite Zinc Plated  64-9701 thru 64-9712	64-9701	1" x 1"	144 ea	\$0.23	\$0.29
	64-9702	1" x 1-1/2"	144 ea	\$0.26	\$0.36
	64-9703	1-1/2" x 1-1/2"	144 ea	\$0.37	\$0.58
	64-9704	1-1/2" x 2"	48 ea	\$0.53	\$0.74
	64-9705	2" x 2"	48 ea	\$0.59	\$0.91
	64-9706	2-1/2" x 3"	48 ea	\$0.70	\$1.07
	64-9707	3" x 3"	48 ea	\$0.74	\$1.10
	64-9708	4" x 4"	24 ea	\$1.10	\$1.46
	64-9709	5" x 5"	24 ea	\$1.19	\$1.67
	64-9710	6" x 6"	24 ea	\$1.67	\$2.20
	64-9711	6" x 8"	12 ea	\$3.00	\$3.45
	64-9712	8" x 8"	12 ea	\$3.33	\$4.15
Mending Plates - Heavy Duty  64-200	64-200	5" x 1"	24 ea	\$1.10	\$1.46
Valance Bracket  64-100	64-100-61	Zinc Plated	20 ea	\$0.51	\$0.74
	64-100-7	White	100 ea	\$0.51	\$0.74
Screw Eyes Brite Zinc Finish  66-8 66-10 66-12	66-8	1-5/8", 100 ea per box	100 ea	\$0.14	\$0.23
	66-10	1-3/8", 100 ea per box	100 ea	\$0.13	\$0.22
	66-12	1-3/16", 200 ea per box	200 ea	\$0.12	\$0.21
Tenter Hooks  66-280 66-2815	66-280-1	200 ea per box	1 box	\$10.78	
	66-280-2	1000 ea per box	1 box	\$39.91	
	66-2815	Cup Hook	100 ea	\$0.23	\$0.26
	66-2815B	1", 6 ea per bag	20 bags	\$1.55	\$0.79

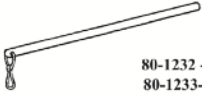
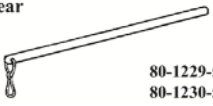





Batons

Illustration	Item No	Description	Full Pack		Broken Pack
			Q'ty	Price	
Batons with Adapter (3/8" Fiberglass) White  80-1242-25 80-1243-25 80-1244-25 80-1245-25 80-1246-25	80-1242-25	3/8" Fiberglass.w/adapter 30" Long	20 ea	\$2.15	\$2.75
	80-1243-25	3/8" Fiberglass.w/adapter 36" Long	20 ea	\$2.15	\$2.75
	80-1244-25	3/8" Fiberglass.w/adapter 48" Long	20 ea	\$3.25	\$4.13
	80-1245-25	3/8" Fiberglass.w/adapter 60" Long	20 ea	\$5.45	\$6.55
	80-1246-25	3/8" Fiberglass.w/adapter 72" Long	20 ea	\$6.55	\$7.65
Acrylic Clear  80-1239-58 80-1240-58	80-1239-58	3/8" Acrylic Clear. w/adapter 30" Long	20 ea	\$2.15	\$2.75
	80-1240-58	3/8" Acrylic Clear. w/adapter 36" Long	20 ea	\$2.15	\$2.75
	80-1241-58	3/8" Acrylic Clear. w/adapter 48" Long	20 ea	\$3.25	\$4.13
Acrylic Clear 1/2" Fluted  80-1259-58	80-1259-58	1/2" Acrylic Clear. w/adapter 48" Long.Fluted	20 ea	\$3.25	\$4.13



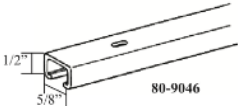
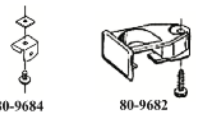

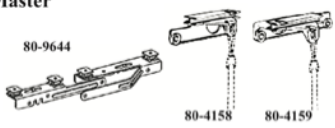
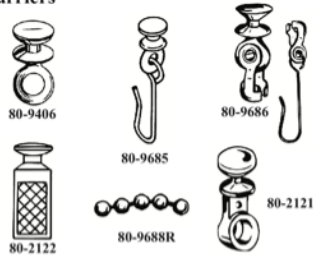
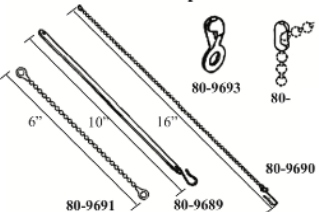

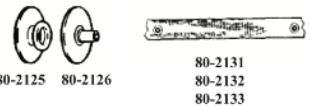
Batons

Illustration	Item No	Description	Full Pack		Broken Pack
			Q'ty	Price	
Batons with Harness Snap (3/8" Fiberglass) White  80-1232-25 80-1233-25 80-1234-25 80-1235-25 80-1236-25	80-1232-25	3/8" Fiberglass. w/snap 30" Long	20 ea	\$2.15	\$2.75
	80-1233-25	3/8" Fiberglass. w/snap 36" Long	20 ea	\$2.15	\$2.75
	80-1234-25	3/8" Fiberglass. w/snap 48" Long	20 ea	\$3.25	\$4.13
	80-1235-25	3/8" Fiberglass. w/snap 60" Long	20 ea	\$5.45	\$6.55
	80-1236-25	3/8" Fiberglass. w/snap 72" Long	20 ea	\$6.55	\$7.65
Acrylic Clear  80-1229-58 80-1230-58	80-1229-58	3/8" Acrylic Clear. w/snap 30" Long	20 ea	\$2.15	\$2.75
	80-1230-58	3/8" Acrylic Clear. w/snap 36" Long	20 ea	\$2.15	\$2.75
Acrylic Clear 1/2" Fluted  80-1249-58	80-1249-58	1/2" Acrylic Clear. w/snap 48" Long. Fluted	20 ea	\$3.25	\$4.13
Batons Components  80-4165-58  80-4166-81	80-4165-58	Baton Holdet. Clear 20ea / bag	5 bags	\$7.27	\$10.19
	80-4166-81	Hex Washer Head Screw Brite Zinc. 20ea / bag	5 bags	\$4.61	\$6.46



Series 80-9046

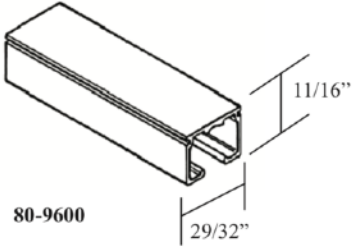
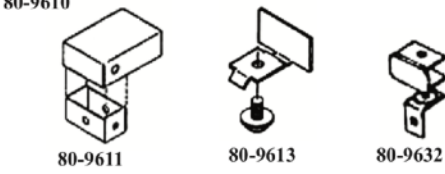
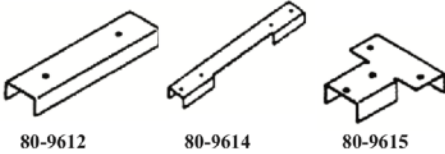
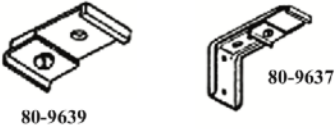
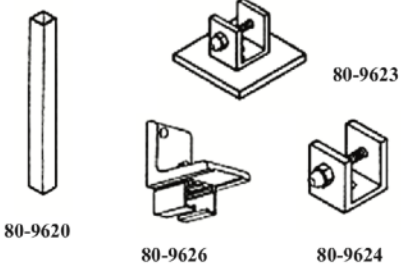
For Grommated Cubicle Curtains or Hand Draw Pinch-Pleated Draperies
 Accordia-Fold or Ripplefold System

Illustration	Item No	Description	Full Pack		Broken Pack
			Q'ty	Price	
Track 	80-9046-12-90	12'	360 ft 180 ft	\$1.23 \$1.23	\$1.73
	80-9046-16-90	16'	480 ft 240 ft	\$1.16 \$1.16	\$1.63
	80-9046-16-7	16'	480 ft 240 ft	\$1.16 \$1.16	\$1.63
	Cut Add 10%				\$1.35
End Stop 	80-9684	End Stop with Pin Hole Return	20 prs 400 prs	\$1.51 \$1.28	\$2.11
	80-9682	End Cap	20 ea 400 ea	\$0.83 \$0.67	\$1.16
Splice 	80-9646	Splice	20 ea	\$1.19	\$1.65
Master 	80-9644	Master , Two-way	10 prs	\$2.54	\$3.54
	80-4158	Baton Master , Right	20 ea	\$1.66	\$2.33
	80-4159	Baton Master , Left	20 ea	\$1.66	\$2.33
Carriers 	80-9406-7	Molded Slide	100 ea 1000 ea	\$0.15 \$0.09	\$0.17
	80-9685	Molded Slide with Metal Hook	100 ea 500 ea	\$0.36 \$0.26	\$0.40
	80-9686	with Eyelet	10 ea 100 ea	\$1.31 \$0.98	\$1.61
	80-9688R	Stainless Steel No.10 Bead Chain	500 ft	\$1.31	\$1.61
	80-2121-7	Snap Tab	1000 ea	\$0.19	\$0.31
	80-2122-7	Sew-on Tab	1000 ea	\$0.12	\$0.21
Cubicle Curtain Drop 	80-9689	PVC , 16' Long	100 ea 500 ea	\$0.59 \$0.55	\$0.88
	80-9690	Drop Chain with Hook , 16" Long	100 ea	\$1.03	\$1.45
	80-9691	6" Drop Chain Connector	100 ea	\$0.45	\$0.63
	80-9692	Coupler for Lengthening chain	200 ea	\$0.33	\$0.45
	80-9693	Ring for Shortening Chian	200 ea	\$0.42	\$0.59
	Sew on Pleaters 	80-2111	2" Accordia-fold and	1000 ea	\$0.12
80-2114		Ripplefold	100 ea	\$0.48	\$0.69
Snap and Tape 	80-2125	Overlap Master	100 ea 500 ea	\$0.23 \$0.10	\$0.33
	80-2126	Male Snap	100 ea 500 ea	\$0.23 \$0.10	\$0.33
	80-2131	Eyelet for Male Snap	100 yds	\$1.32	\$1.85
	80-2132	8-1/2" Spacing	100 yds	\$1.32	\$1.85
	80-2133	10" Spacing	100 yds	\$1.32	\$1.85



Series 80-9600

For Grommeted Cubicle Curtain or Hand-Drawn Draperies

Illustration	Item No	Description	Full Pack		Broken Pack
			Q'ty	Price	
Track 	80-9600-12	12'	300 ft 156 ft	\$1.21 \$1.50	\$1.70
	80-9600-14	14'	350 ft 182 ft	\$1.21 \$1.50	\$1.63
	80-9600-16	16'	400 ft 208 ft	\$1.16 \$1.50	\$1.63
	80-9600-20	20'	500 ft 260 f	\$1.16 \$1.50	\$1.63
	Cut Add 10%				\$1.70
End Stop & Pull Out 	80-9610	End Stop	10 ea	\$0.53	\$0.75
	80-8611	Pull out	10 ea	\$0.53	\$0.75
	80-9613	End Cap	10 ea	\$1.13	\$1.58
	80-9632	End Stop with Pendulum	10 prs	\$2.70	\$3.77
Spices, Joiner 	80-9612	Splice	10 ea	\$1.44	\$2.01
	80-9614	Joining Sleeve	10 ea	\$2.75	\$3.93
	80-9615	T-Bracket	10 ea	\$2.53	\$3.58
Bracket, Support 	80-9639	Ceiling Bracket	20 ea	\$1.27	\$1.58
	80-9637	Adjustable Bracket 2" to 2-7/8"	10 ea	\$1.69	\$2.37
Suspension System 	80-9620	Tubing, 12' Long	144 ft	\$1.58	\$2.22
	80-9623	Ceiling Flange	10 ea	\$6.04	\$8.46
	80-9626	Wall Flange	10 ea	\$6.25	\$8.75
	80-9624	Socket	10 ea	\$3.53	\$4.95



Series 80-9600

For Grommeted Cubicle Curtain or Hand-Drawn Draperies

Illustration	Item No	Description	Full Pack		Broken Pack
			Q'ty	Price	
Carriers 	80-9616	Carrier with Metal Hook	100 ea	\$0.56	\$0.78
	80-9633	Carrier with Steel Loop	100 ea	\$0.44	\$0.62
	80-9634	Carrier with Molded Loop	500 ea	\$0.56	\$0.79
Master Carriers Hand-draw 	80-9630	Master, Two-way	10 prs	\$5.45	\$6.58
	80-9631	Master, One-way	10 ea	\$3.25	\$4.24
Cubicle Curtain Drop Hangers 	80-9689	PVC, 16' Long	10 ea 100 ea 500 ea 2000 ea	\$0.79 \$0.54 \$0.51 \$0.44	\$1.10
	80-9690	Drop Chain with Hook, 16" Long	100 ea	\$1.03	\$1.45
	80-9688-1	No. 10 Metal Bead Chain	100 ft	\$1.31	\$1.61
	80-9688-2	No. 10 Metal Bead Chain	333 ft (100m)	\$1.09	
	80-9691	6" Drop Chain Connector	100 ea	\$0.45	\$0.63
	80-9692	Coupler for Lengthening Chain	200 ea	\$0.33	\$0.45
	80-9693	Ring for Shortening Chain	200 ea	\$0.42	\$0.59

Curved Rod - Track Changed in Cut Price

Curved One : \$ 1.65 / ft - Minimum \$16.50 / ea

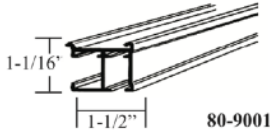

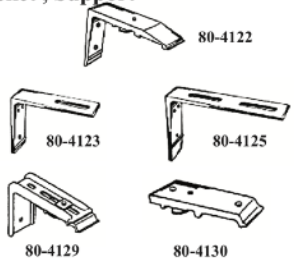
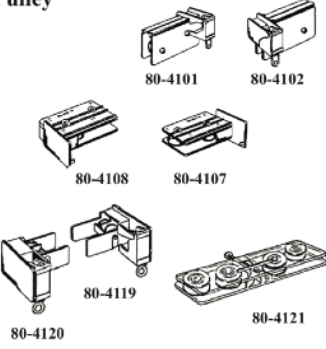
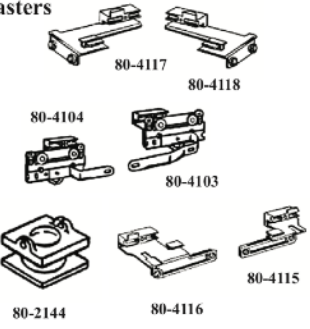
Bended One : Approximately 14" Radius \$ 11.00

Bend - Minimum \$ 16.50 / Rod



Series 80-9001

Cord Draw , Wall or Ceiling Mount For Pinch Pleat , Accordia-fold or Ripplefold System.

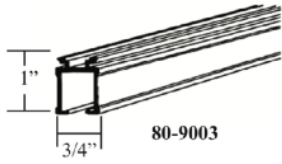

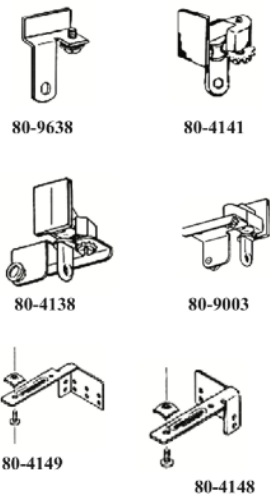
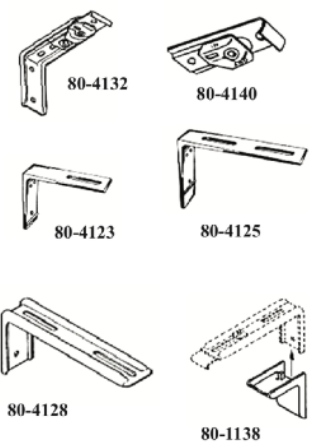
Illustration	Item No	Finish	Description	Full Pack		Broken Pack
				Q'ty	Price	
Track 	80-9001-12	7 90	12'	192 ft	\$2.13 \$2.10	\$2.98 \$2.94
	80-9001-16	7 90	16'	256 ft	\$2.13 \$2.10	\$2.98 \$2.94
	80-9001-18	7 90	18'	288 ft	\$2.13 \$2.10	\$2.98 \$2.94
	80-9001-20	7	20'	320 ft	\$2.19	\$3.06
	Cut Add 10%					\$2.34 \$2.31
Spices 	80-4109		Splice	20 ea	\$5.02	\$7.03
Bracket , Support 	80-4122	7 90	Wall Base, Return 3-1/2" Clearance 1-1/2"	20 ea	\$3.87 \$2.86	\$5.50 \$3.98
	80-4123	7 90	Wall Base , Return 3-1/2" to 4-1/2" Clearance 2-1/4" to 3-1/4" Use with 94130	20 ea	\$4.49 \$3.65	\$6.28 \$5.16
	80-4125	7 90	Double Wall Base , Return 6" Clearance 1-1/4" to 2-1/2" Use with 94130	20 ea	\$6.51 \$5.50	\$9.14 \$7.63
	80-4130	7 90	Ceiling Bracket	20 ea	\$2.30 \$2.02	\$3.20 \$2.86
	80-4129	7 90	Support, Return 3-1/2" to 4-1/2" Clearance 1-3/4" to 3-1/4"	20 ea	\$3.42	\$4.83
Pulley 	80-4101		1" Ball Bearing , Right Hand with Drapery Return Plate	20 ea	\$4.11	\$5.76
	80-4102		Left Hand Both need 9997 Notching Tool	20 ea	\$4.11	\$5.76
	80-4119		1/2" End Pulley Right , with Drapery Return Plate	20 ea	\$3.83	\$5.36
	80-4120		Left Hand Notching	20 ea	\$3.83	\$5.36
	80-4107		Right Hand for One-way Draw	20 ea	\$1.94	\$2.72
	80-4108		Left Hand	20 ea	\$1.94	\$2.72
	80-4121		Intermediate Pulley for Pinch-pleat Accordia-fold or Ripplefold	10 ea	\$6.13	\$8.59
Masters 	80-4117		Butt for Snap , Right Hand	20 ea	\$2.31	\$2.94
	80-4118		Left Hand	20 ea	\$2.31	\$2.94
	80-4103		Overlap for Hooks , Right Hand Use with 9670 Carrier	20 ea	\$7.60	\$10.65
	80-4104		Left Hand	20 ea	\$7.60	\$10.65
	80-4115		Overlap for Sanp Right Hand , Require 92114	20 ea	\$2.00	\$2.54
	80-4116		Left Hand , Require 92114	20 ea	\$2.00	\$2.54
	80-2144		Overlap Ripplefold Master Adapter	50 ea	\$1.03	\$1.31

Color No. 7 White 90 Aluminum



Series 80-9003

Baton Draw, Wall or Ceiling Mount. For Grommeted, Pinch Pleat, Accordia-fold or Ripplefold System.

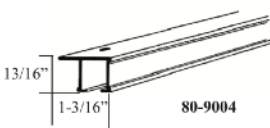

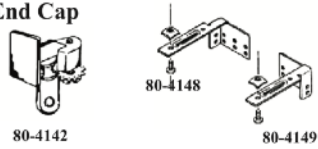
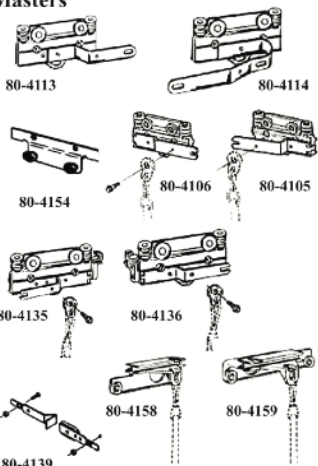
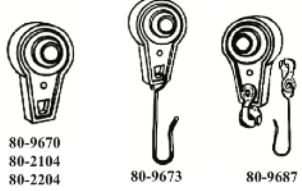
Illustration	Item No	Finish	Description	Full Pack		Broken Pack
				Q'ty	Price	
Track 	80-9003-12	7 90	12'	216 ft	\$1.30 \$1.30	\$1.82 \$1.82
	80-9003-14	7 90	14'	252 ft	\$1.30 \$1.30	\$1.82 \$1.82
	80-9003-16	7 90	16'	288 ft	\$1.30 \$1.30	\$1.82 \$1.82
	80-9003-18	7 90	20'	324 ft	\$1.33 \$1.33	\$1.86 \$1.86
	Cut Add 10%					\$1.43 \$1.43
Spices 	80-4110		Splice	10 ea	\$5.78	\$8.09
End Cap 	80-9683		End Stop	20 prs 400 prs	\$1.66 \$1.45	\$2.33
	80-4141		End Cap	20 ea	\$1.78	\$2.49
	80-4137		End Cap with Return Plate Right Hand Ripplefold Accordia-fold	20 ea	\$2.66	\$3.72
	80-4138		Left Hand	20 ea	\$2.66	\$3.72
	80-4148		Extender with Return Plate Right Hand, Pinch-pleats	100 ea	\$1.10	\$1.54
	80-4149		Left Hand, 1-1/8" Return	100 ea	\$1.10	\$1.54
Brackets 	80-4132	7 90	Wall Bracket Return 3-1/2" to 4-1/2" Clearance 2" to 3"	20 ea	\$1.41 \$1.27	\$1.97 \$1.74
	80-4140		Ceiling Bracket	20 ea	\$0.51	\$0.73
	80-4125	7 90	Double Wall Bracket Base Return 6", Use with 94140 Clearance 1-1/4" to 2-1/2"	20 ea	\$6.51 \$5.50	\$9.14 \$7.63
	80-4123	7 90	Wall Bracket , Return 4-1/2" Clearance 2-1/4" to 3-1/4"	20 ea	\$4.49 \$3.65	\$6.28 \$5.16
	80-4128		Double Bracket , Support Base Return 5" to 6"	20 ea	\$0.73	\$1.01
	80-1138		Center Support Cap	20 ea	\$0.85	\$1.19

Color No. 7 White 90 Aluminum



Series 80-9004

Baton Draw, Wall or Ceiling Mount. For Grommeted, Pinch Pleat, Accordia-fold or Ripplefold System.

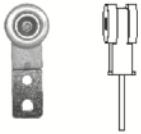



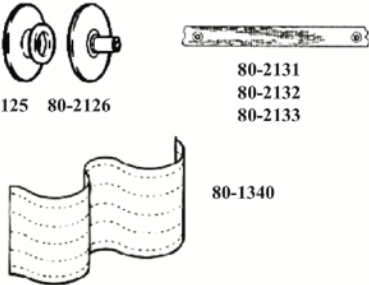
Illustration	Item No	Finish	Description	Full Pack		Broken Pack
				Q'ty	Price	
Track 	80-9004-12	7	12'	216 ft	\$1.51	\$2.11
		90		216 ft	\$1.46	\$2.05
	80-9004-16	7	16'	288 ft	\$1.51	\$2.11
		90		288 ft	\$1.46	\$2.05
	Cut Add 10%					\$1.66 \$1.61
End Stop 	80-9683	80-9683	End Stop	20 pr 400 pr	\$1.66 \$1.45	\$2.33
End Cap 	80-4142		End Cap	20 ea	\$1.73	\$2.41
	80-4148		Extender with Return Plate for Pinch-pleats, Right Hand	100 ea	\$1.10	\$1.54
	80-4149		Left Hand, 1-1/8" Return	100 ea	\$1.10	\$1.54
Masters 	80-4113		For Pinch-pleats and 9670 Carrier for Hidden Baton	20 ea	\$4.60	\$6.39
	80-4114		Left Hand	20 ea	\$4.60	\$6.39
	80-4105		For Pinch-pleats or Accordia fold Right Hand	20 ea	\$4.84	\$6.71
	80-4106		Left Hand	20 ea	\$4.84	\$6.71
	80-4135		For Ripple-fold, Right Hand	20 ea	\$5.78	\$8.07
	80-4136		Left Hand	20 ea	\$5.78	\$8.07
	80-4154		For Ripplefold, Double Hung Adapter Kit, 2 per bag	10 bags	\$3.23	\$4.51
	80-4158		Baton Master, Right Hand	20 ea	\$1.66	\$2.33
	80-4159		Left Hand	20 ea	\$1.66	\$2.33
	80-4139		Magnetic Master Kit	10 ea 100 ea	\$3.18 \$2.95	\$4.39
Carriers 	80-9670		Ball Bearing Carrier 1"	100 ea 1000 ea	\$0.36 \$0.35	\$0.50
	80-2104		Ball Bearing Carrier 3/4"	100 ea 1000 ea	\$0.35 \$0.32	\$0.39
	80-2204		Ball Bearing Carrier 1/2"	100 ea 1000 ea	\$0.36 \$0.32	\$0.39
	80-9673		Ball Bearing with Hook	100 ea 1000 ea	\$0.54 \$0.52	\$0.86
	80-9687		Ball Bearing with Hook and Eyelet , No Chain	100 ea	\$1.61	\$1.16

Color No. 7 White 90 Aluminum



Series 80-9004

Baton Draw, Wall or Ceiling Mount. For Grommeted, Pinch Pleat, Accordia-fold or Ripplefold System.

Illustration	Item No	Description	Full Pack		Broken Pack
			Q'ty	Price	
Two Wheels Ball Bearing Metal Pendants  80-3208	80-3208	Two Wheels Ball Bearing Metal Pendants	100 ea 1000 ea	\$0.42 \$0.39	\$0.50
Carriers 	80-9688-1	No. 10 Metal Bead Chain	100 ft	\$1.31	\$1.61
	80-9688-2	No. 10 Metal Bead Chain	333 ft (100m)	\$1.09	
	80-9406	Molded Slide	100 ea 1000 ea	\$0.15 \$0.09	\$0.18
	80-9685-7	Molded Slide , Metal Hook	100 ea 1000 ea	\$0.39 \$0.28	\$0.44
	80-9686	Molded Slide with Eyelet	100 ea 1000 ea	\$1.31 \$0.98	\$1.61
	80-2121	Sanp Tap Carrier	100 ea	\$0.87	
	80-2122	Sew-on Tap	1000 ea	\$0.19	
	80-4170	Molded Slide	1000 ea	\$0.19	\$0.25
Sew-on Pleaters 	80-2111	2" Accordia-fold and Ripplefold	1000 ea	\$0.12	\$0.20
	80-2114	Overlap	100 ea	\$0.48	\$0.69
Stiffeners 	80-4145	Overlap Stiffener with Grommet for Hooks (Pinch-pleat)	100 ea 1000 ea	\$0.83 \$0.72	\$1.23
	80-4146	Overlap Stiffener with Grommet use with if Panel Hang under Track	100 ea 1000 ea	\$0.77 \$0.72	\$1.18
Snaps and Tapes 	80-2125	Male Sanp	100 ea	\$0.23	\$0.33
	80-2126	Eyelet for Male Snap	100 ea	\$0.23	\$0.33
	80-2131	Accordia-fold Sanp Tape 7-1/2" Spacing	100 yds	\$1.32	\$1.85
	80-2132	8-1/2" Spacing	100 yds	\$1.32	\$1.85
	80-2133	10" Spacing	100 yds	\$1.32	\$1.85
	80-1340-1-52	2" Polyester Buckrum 100 yds per roll	1 roll	\$73.08	



Series 80-7900 Hospital Track

Illustration	Item No	Description	Full Pack		Broken Pack
			Q'ty	Price	
<p>80-7900</p>	80-7900-12	12'	192 ft 96 ft	\$2.00 \$2.54	\$3.61
	80-7900-14	14'	224 ft 112 ft	\$2.00 \$2.54	\$3.61
	80-7900-16	16'	256 ft 128 ft	\$2.00 \$2.54	\$3.61
<p>80-7901</p>	80-7901-90	41" Long with 90 Degree Bend	2 ea	\$10.82	\$15.17
<p>80-7910 80-7911</p> <p>80-7913 80-7911</p>	80-7910	End Stop	10 ea	\$0.47	\$0.68
	80-7911	Pull out	10 ea	\$0.54	\$0.74
	80-7913	Carrier Stop	10 ea	\$0.54	\$0.74
	80-7920	End Cap with Carrier Gate	20 ea	\$0.59	\$0.96
<p>7912</p>	80-7912-90	Splice Joiner, Aluminum	1 ea	\$2.43	
	80-7912-7	Splice Joiner, White	1 ea	\$2.60	
<p>80-7918</p>	80-7918	Bead Chain, Metal Hook	100 ea 500 ea	\$0.77 \$0.74	\$1.03
<p>80-9693 80-9692</p> <p>80-9691 80-9689</p> <p>6" 10" 16"</p>	80-9689	PVC, 16" Long	100 ea 500 ea	\$0.59 \$0.55	\$0.88
	80-9690	Drop Chain with Hook, 16" Long	100 ea	\$1.03	\$1.49
	80-9691	6" Drop Chain Connector	100 ea	\$0.42	\$0.55
	80-9692	Coupler for Lengthening Chian	200 ea	\$0.22	\$0.31
	80-9693	Ring for Shortening Chain	200 ea	\$0.43	\$0.61

Curved Rod - Track Changed in Cut Price

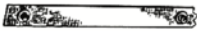

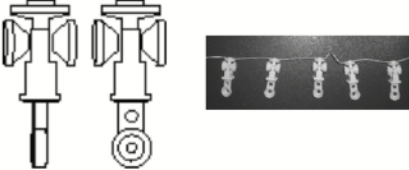

Curved One : \$ 1.65 / ft - Minimun \$16.50 / ea

Bended One : Approximately 14" Radius \$ 11.00

Bend - Minimum \$ 16.50 / Rod








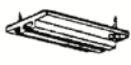





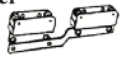

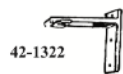





Ripplefold Snap Tape and Batons

Illustration	Item No	Description	Full Pack		Broken Pack
			Q'ty	Price	
Ripplefold Snap Tape  80-2145	80-2145	Ripplefold Snap Tape 4-1/2" On Center	100 yds 1000 yds	\$1.66 \$1.57	\$2.35
Ripplefold Carrier  80-2140 thru 80-2143	80-2140	120% Fullness 1-7/8" On Center	1000 ea	\$0.29	\$0.40
	80-2141	100% Fullness 2-1/8" On Center	1000 ea	\$0.29	\$0.40
	80-2142	80% Fullness 2-3/8" On Center	1000 ea	\$0.29	\$0.40
	80-2143	60% Fullness 2-5/8" On Center	1000 ea	\$0.29	\$0.40
Two Wheel Ripplefold Carrier  80-2240 thru 80-2243	80-2240	120% Fullness 1-7/8" On Center	500 ea	\$0.42	\$0.55
	80-2241	100% Fullness 2-1/8" On Center	500 ea	\$0.42	\$0.55
	80-2242	80% Fullness 2-3/8" On Center	500 ea	\$0.42	\$0.55
	80-2243	60% Fullness 2-5/8" On Center	500 ea	\$0.42	\$0.55
Ripplefold Pendant  80-4270	80-4270	Ripplefold Pendant	1000 ea	\$0.11	\$0.17



Heavy Duty and Standard I Beam Track and Components

Illustration	Item No	Description	Full Pack		Broken Pack
			Q'ty	Price	
Heavy Duty I Beam Track Aluminum  42-1387	42-1387	16'	560 ft 192 ft	\$1.76 \$1.98	\$2.22
End Stop  42-2930	42-2930	End Stop	10 pr	\$1.93	\$2.31
Master Carrier  42-3310	42-3310	Master Carrier	10 pr	\$6.33	\$7.43
Bracket  42-3321  42-3322	42-3321	1-1/4" Projection	10 ea	\$1.93	\$2.75
	42-3322	2-1/2" Projection	10 ea	\$2.37	\$3.03
Bumper Carrier  42-3350  42-3351	42-3350	Well with Slide Guard	250 ea	\$1.05	\$1.27
	42-3351	Metal (Brass) wheel	250 ea	\$1.75	\$1.97
Splicer  42-3425	42-3425	Splicer	10 ea	\$2.15	\$2.48
Ceiling Bracket  42-3427	42-3427	Ceiling Bracket	100 ea	\$0.83	\$1.05

Standard I Beam Track Aluminum  42-1212	42-1212	16'	400 ft 192 ft	\$0.94 \$1.10	\$1.65
End Stop  42-1930	42-1930	End stop	10 pr	\$1.38	\$1.93
Master Carrier  42-1165	42-1165	Master Carrier	10 pr	\$5.78	\$6.93
Bracket  42-1321  42-1322	42-1321	1-1/4" Projection	10 ea	\$1.38	\$1.50
	42-1322	1-1/4" x 2-1/2" Projection	10 ea	\$1.60	\$1.87
Carrier  42-1049  42-1350  42-1351	42-1049	Self Lubricating Wheels	200 ea	\$0.18	\$0.24
	42-1350	Wheel with Slide Guard	200 ea	\$0.44	\$0.55
	42-1351	Metal (Brass) wheel	200 ea	\$1.08	\$1.65
Splicer  42-1425	42-1425	Splicer	10 ea	\$1.76	\$2.04
Ceiling Bracket  42-1427	42-1327	Ceiling Bracket	100 ea	\$0.61	\$0.83



DK Drapery Hardware

826 Wall St - Los Angeles, CA 90014
Tel: (213)327-0020 Fax: (213)327-0030